

AB-BAT12V5AH-AB



Specifications

Nominal Voltage	12V	
Number of cell	6 cells	
Rated capacity(15min.rat)	21 Watts/cell	
Dimensions	Length	90±1mm(3.54inch)
	Width	70±1mm(2.76inch)
	Height	101±1mm(3.98inch)
	Total Height	107±1mm(4.21inch)
Approx. Weight	1.62kg(3.57lbs)±4%	

Outer dimensions (mm)

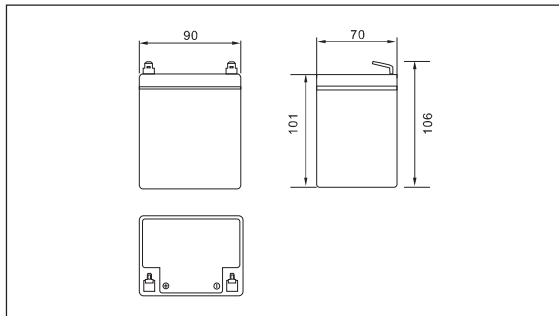

Terminal Type (mm)

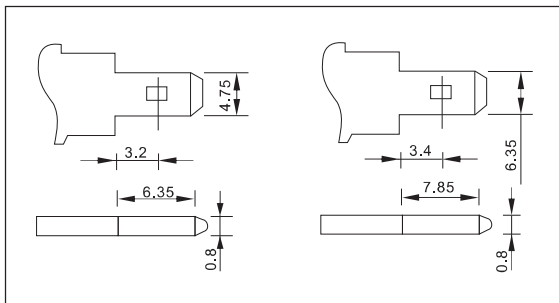

Characteristics

Capacity(20HR,25°C)	5Ah	
Capacity(15min.rate,25°C)	21 Watts/cell	
Terminal type	T2/T1	
Internal resistance (Fully charged,25°C)	Approx.23m Ω	
Capacity affected by temperature (10HR)	40°C	102%
	25°C	100%
	0°C	85%
	-15°C	65%
Self-discharge (25°C)	3month	Remaining Capacity:91%
	6month	Remaining Capacity:82%
	12month	Remaining Capacity:65%
Nominal operating temperature	25°C ±3°C(77°F ±5°F)	
Operating temperature range	Discharge	-15°C~50°C(5°F~122°F)
	Charge	-10°C~50°C(14°F~122°F)
	Storage	-20°C~50°C(-4°F~122°F)
Float charging voltage(25°C)	13.50 to 13.80V Temperature compensation: -18mV/°C	
Cyclic charging voltage(25°C)	14.50 to 15.00V Temperature compensation: -30mV/°C	
Maximum charging current	1.5A	
Terminal material	Copper	
Maximum discharge current	75A(5 sec.)	
Designed floating life(20°C)	5years	

Construction

Component	Positive plate	Negative plate	Container	Cover	Separator	Electrolyte	Safety valve	Terminal
Raw material	Leaddioxide	Lead	ABS	ABS	AGM	Sulfuric acid	Rubber	Copper

Constant Current Discharge Characteristics Unit:A(25°C,77°F)

F.V/Time	5min	10min	15min	20min	30min	45min	60min	2h	3h	4h	5h
1.60V/cell	22.8	14.0	11.0	8.71	5.90	4.37	3.58	1.84	1.31	1.05	0.90
1.67V/cell	21.7	13.4	10.6	8.36	5.71	4.23	3.49	1.82	1.29	1.04	0.89
1.70V/cell	21.2	13.0	10.3	8.19	5.61	4.15	3.43	1.81	1.29	1.04	0.89
1.75V/cell	20.3	12.5	10.0	7.91	5.47	4.05	3.36	1.78	1.28	1.03	0.89
1.80V/cell	19.1	11.8	9.5	7.49	5.27	3.90	3.26	1.74	1.24	1.00	0.86

Constant Power Discharge Characteristics Unit:W(25°C,77°F)

F.V/Time	5min	10min	15min	20min	30min	45min	60min	2h	3h	4h	5h
1.60V/cell	43.7	27.2	21.8	17.2	11.7	8.65	7.08	3.66	2.62	2.11	1.81
1.67V/cell	41.7	26.0	21.0	16.6	11.3	8.38	6.90	3.62	2.60	2.09	1.80
1.70V/cell	40.6	25.3	20.5	16.2	11.1	8.22	6.80	3.60	2.59	2.08	1.79
1.75V/cell	38.9	24.2	19.8	15.7	10.8	8.02	6.66	3.55	2.57	2.07	1.78
1.80V/cell	36.7	22.8	18.7	14.8	10.4	7.73	6.46	3.46	2.50	2.01	1.73

Note: The above characteristics data can be obtained within three charge or discharge cycles.

AB-BAT12V5AH-AB

● Discharge characteristics(25°C)

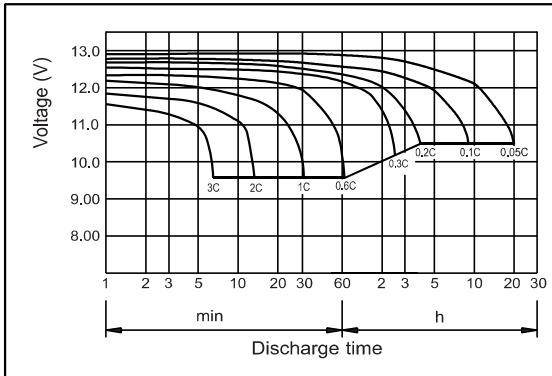

● Charging characteristics (25°C)

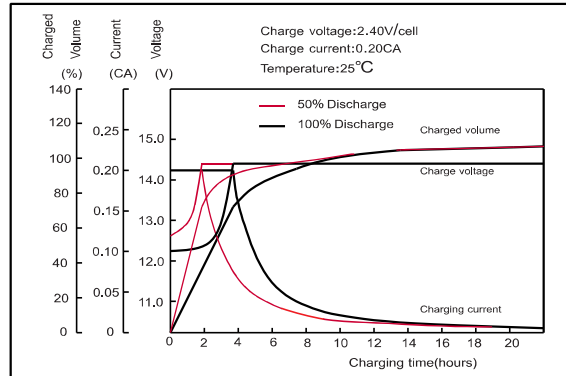

● Effect of Temperature on Capacity

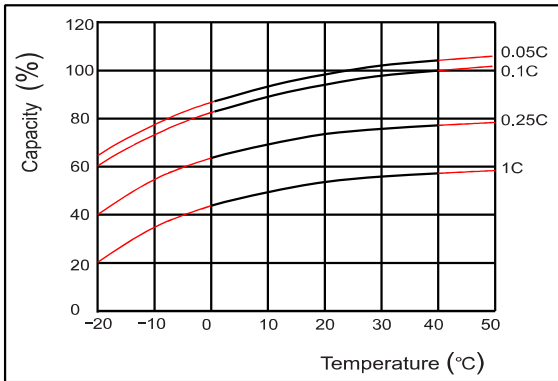

● Self-discharge characteristics

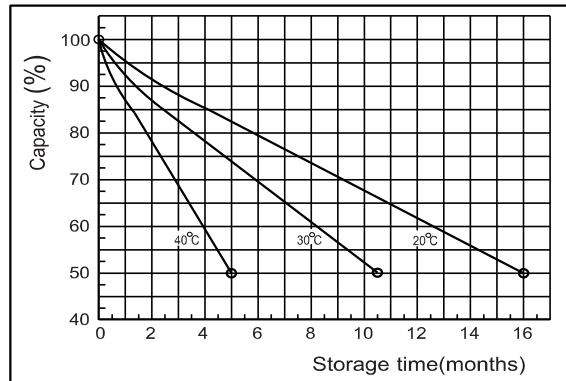

● Floating Life on Temperature

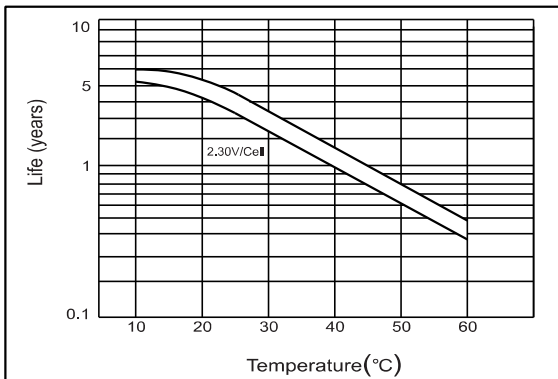

● Cycle service Life on D.O.D (25°C)

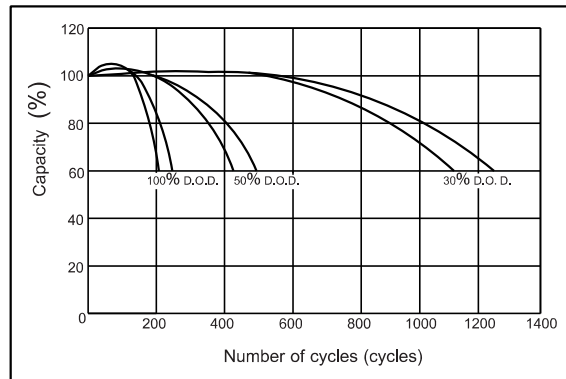

● The relationship for OCV and Capacity (25°C)

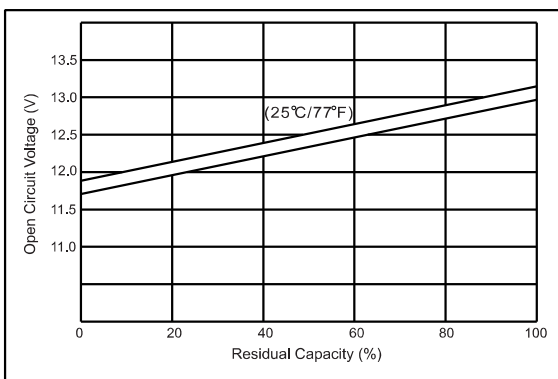

● The relationship for Charging voltage and Temperature

