



ARES PLUS 230V
Intelligent True On-Line UPS
User Manual

1, 2, and 3 kVA

Table of Contents

1. Safety Instructions and Storage/ Battery Care	2
1.1 Safety Instructions	2
1.2 Storage / Battery Care	5
2. Product Introduction	6
2.1 General Characteristics	6
2.2 Special Features	7
3. UPS Functional Descriptions	8
3.1 Front Panel Display	8
3.2 Rear Panel	13
3.3 Communication Port Explanation	15
4. Installation and Operation	16
4.1 Unpacking	16
4.2 Selecting Installation Position	19
4.3 Operation	20
5. UPS System Block Diagram	34
6. Maintenance Guide	35
6.1 Troubleshooting	35
6.2 Error Codes and Their Meanings	38
6.3 Maintenance	38
7. Communication Software	39
7.1 Hardware Setup	39
7.2 Software Installation	39
8. Optional Communication Cards	40
8.1 R2E (second RS-232) card	40
8.2 USE (USB) card	40
8.3 DCE (Dry Contact) card	41
8.4 SNMP Cards	42
9. Specifications Convertible Type (Rack / Tower)	43

1. Safety Instructions and Storage/ Battery Care

1.1 Safety Instructions

SAVE THESE INSTRUCTIONS.

This manual contains important instructions that should be followed during installation and maintenance of the UPS and batteries.

1. Do not open the case as there are no serviceable parts inside. Opening the case will void your warranty and introduces the risk of electric shock.
2. Do not try to repair the unit yourself. Doing so will void your warranty. Contact your local supplier for repairs.
3. If liquids are spilt onto the UPS or foreign objects dropped into the unit the UPS could be damaged, users could be subject to electric stock, and the warranty will become null and void.
4. Do not install the UPS in an environment with sparks, smoke, or hazardous gas.
5. This UPS is equipped with an EMI filter. To prevent potential leakage current hazards ensure that the AC mains supply is securely grounded. Because of small leakage currents generated by the EMI filter in the UPS it is necessary to double check that the ground wire of the UPS is properly grounded before connecting the UPS to the AC mains
6. This UPS is designed to be installed and commissioned in a sheltered, controlled environment as follows:
 - Ensure that the UPS is installed within the proper environmental range. (0-40°C and 0-90% non-condensing humidity). High ambient temperature reduces battery life.
 - Do not install the UPS in direct sunlight. Your warranty may be void if the batteries fail
 - Do not install the UPS in an inflammable or otherwise hazardous environment.
 - Avoid vibration and areas subject to physical impact.
 - Avoid any area with sparks.
 - Dusty, corrosive, and salty environments can damage any UPS.
 - Install the UPS indoors as it is not designed for installation outdoors.
7. To prevent overheating of the UPS keep all ventilation openings free from obstruction, and do not place anything on top of the UPS. Keep the UPS rear panel 20 cm away from the wall or other obstructions.

8. Install the UPS in a ventilated area, ideally exchanging 5 m³ of air per hour, because the chemical reaction during battery charging causes trace gas production. If the batteries suffer breakage electrical arcing could occur in the UPS interior.
9. If the product emits a strange noise or smell please immediately stop using the product and contact your dealer for maintenance.
10. Always switch off the UPS and disconnect the batteries when relocating the UPS. Be aware that, even when disconnected, charged batteries present a possible electric shock hazard.
11. The UPS should be recharged every 2-3 months if unused. If this is not done then the warranty will be null and void. When installed and being used the batteries will be automatically recharged and kept in top condition.
12. Make sure that the AC utility outlet is correctly grounded.
13. Ensure that the input voltage of the UPS matches the utility supply voltage. Use a certified input power cable with the correct plugs and sockets for the system voltage.
14. To ensure safety in all applications where a UPS is hard wired to the electrical supply, ensure that the system is installed by a qualified electrical contractor.
15. The UPS has its own internal energy source (battery). Should the battery be switched on when no AC power is available there could be voltage at the output terminals.
16. Make sure that the AC utility outlet is correctly grounded
17. Install the UPS away from objects that give off excessive heat and areas that are excessively wet.
18. The battery will discharge naturally if the system is unused for a long time
19. This UPS supports electronic equipment in office, telecommunication, process-control, medical, and security applications. Non-authorized technicians are not allowed to install the UPS in the following areas.
 - a. Medical equipment directly related to human life
 - b. Elevators, subway systems, or any other equipment related to human safety.

- c. Public systems or critical computer systems.
20. The UPS offers a CVCF (Constant Voltage Constant Frequency) setting function.
 - a. For correct setting and wiring please contact with your local utility agent.
 - b. Do not set it yourself or your warranty will be void.
 21. This UPS has been designed and constructed to protect your assets from the wide range of power aberrations experienced on utility power lines today. It is your insurance for a reliable, clean and stable voltage supply. It is worth taking care to install the system correctly and to have it maintained correctly by your local dealer.
 22. Do not try to replacement of the battery yourself. Doing so will void your warranty. Contact your local supplier for repairs.
 23. The UPS is intended for installation in a controlled environment.
 24. Install the UPS so that it is not likely to be contacted by people.
 25. The maximum ambient operating temperature is 40°C or equivalent.
 26. Units are considered acceptable for use in a maximum ambient 40°C
 27. **CAUTION - RISK OF EXPLOSION IF BATTERY IS REPLACED BY AN INCORRECT TYPE. DISPOSE OF USED BATTERIES ACCORDING TO THE INSTRUCTIONS.**
 28. **CAUTION - Do not dispose of batteries in a fire. The batteries may explode.**
 29. **CAUTION – Do not open or mutilate batteries. Released electrolyte is harmful to the skin and eyes. It may be toxic.**
 30. **CAUTION– A battery can present a risk of electrical shock and high short circuit current. The following precautions should be observed when working on batteries:**
 - 1) Remove watches, rings, or other metal objects.
 - 2) Use tools with insulated handles.
 - 3) Wear rubber gloves and boots.
 - 4) Do not lay tools or metal parts on top of batteries.
 - 5) Disconnect charging source prior to connecting or disconnecting battery terminals.
 - 6) Determine if battery is inadvertently grounded. If inadvertently grounded, remove source from ground. Contact with any part of a grounded battery can result in electrical shock. The likelihood of such shock can be reduced if such grounds are removed during

installation and maintenance (applicable to equipment and remote battery supplies not having a grounded supply circuit).

31. External battery cabinet installation instructions, please refer to " Battery Bank Installation User's MANUAL"

1.2 Storage / Battery Care

If the UPS is unused for an extended period of time it must be stored in a moderate climate. The batteries should be charged for 12 hours every three months by connecting the UPS to the utility supply and switching on the input breaker located on the UPS rear panel. Repeat this procedure every two months if the storage ambient temperature is above 25°C.



2. Product Introduction

2.1 General Characteristics

1. True on-line technology continuously supplies your critical device with stable, regulated, transient-free, pure-sine-wave AC power.
2. High-efficiency PWM sine-wave topology yields excellent overall performance.
3. The high crest factor of the inverter handles all high in-rush current loads without the need to upgrade the power rating.
4. User-friendly plug-and-play design allows hassle-free installation.
5. Built-in maintenance-free, sealed batteries minimize the need for after-sales service.
6. To protect the unit from overloading, the UPS will automatically switch to bypass mode in 30 seconds if loading is at 105% of rated capacity. It will automatically switch back to inverter mode once the overload condition ceases.
7. Should the output become short-circuited the UPS puts the system in stand-by mode, provides visible and audible alarms, and cuts the output supply automatically until the short circuit situation is resolved manually.

2.2 Special Features

1. Our High Frequency Transformer-less technology and tower-convertible enclosure enables the UPS to be integrated into even the most difficult environments with space constraints.
2. This UPS is equipped with fully digital control logic for greater functionality and enhanced power protection. Digital signal processing (DSP) also provides the UPS with powerful communication capability, which simplifies remote control and monitoring.
3. Our wide input voltage tolerance of 110-300 V allows under-voltage or over-voltage correction without unnecessary battery drain and helps extend battery life.
4. Our DC-start function ensures the start-up of the UPS even during power outages.
5. Our smart battery management system extends the batteries' life span.
6. Our Active Power Factor Correction control function constantly maintains the UPS input power factor at > 0.98 for superb energy efficiency.
7. Our Selectable Bypass input voltage tolerance (sensitivity low/high) prevents under- or over-voltage being supplied to the loads in Bypass mode. The selectable voltage ranges are (i) Bypass Sensitivity Low: many selectable output voltages $\pm 15\%$ and (ii) Bypass Sensitivity High: many selectable output voltages $\pm 10\%$. For example, if the output voltage setting is 230 V the Bypass Sensitivity Low range is 230 V $\pm 15\%$, i.e., 195.5-264.5 VAC.
8. The UPS provides numerous configurable output voltages to match various system voltages.
9. The UPS is designed to comply with various stringent international standards for electromagnetic interference compatibility (EMC).







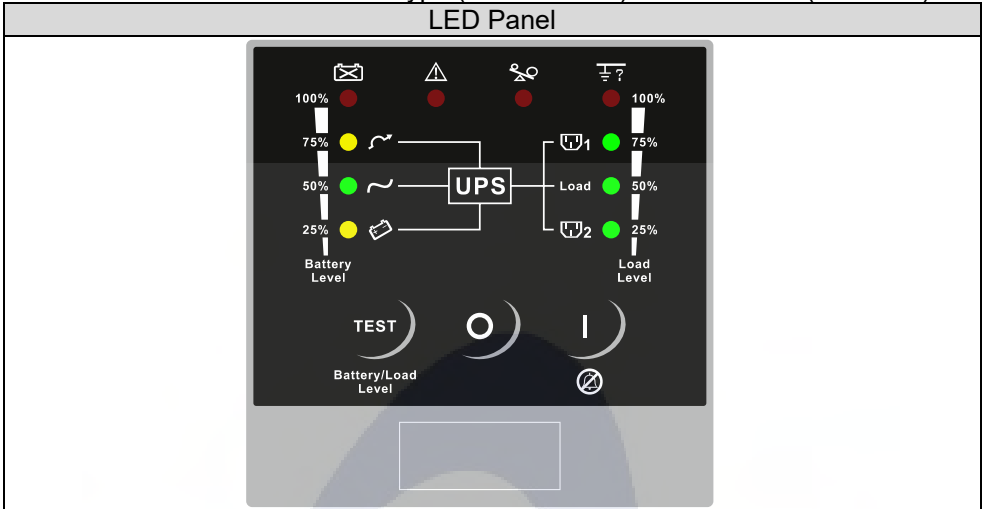

3. UPS Functional Descriptions

3.1 Front Panel Display

3.1.1 ARES RT< Convertible Type (Rack / Tower)> LED Panel (Standard)





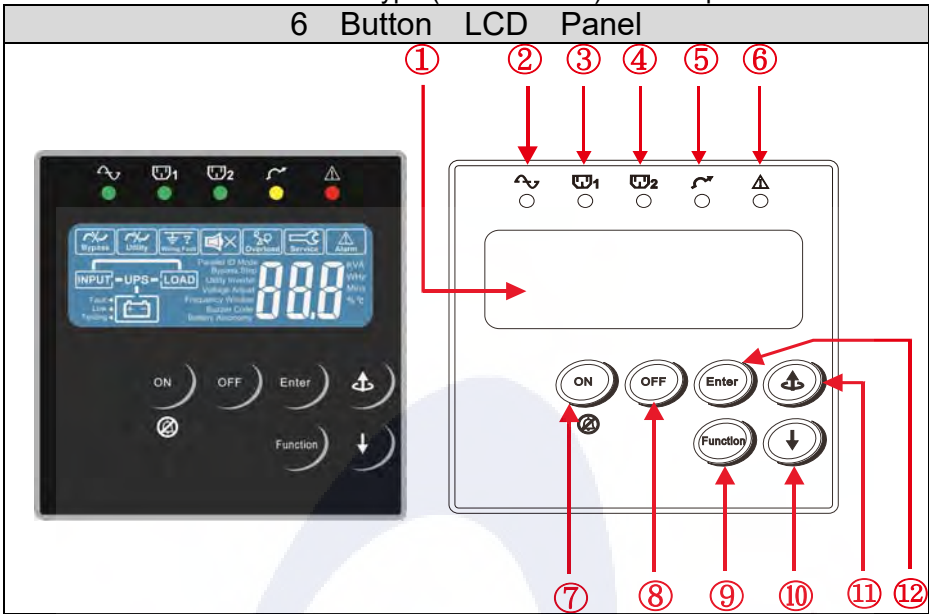

Control Key	Symbol	Description
ON(Alarm Silence)		<ul style="list-style-type: none"> a. UPS Power-On Switch (Press and hold until the buzzer beeps.) b. Alarm silence c. Error Code Display Function Mode After an alarm, press to mute the alarm buzzer and show an Error Code. (Do not hold for > 1 second.)
OFF		UPS Power-Off Switch (Press and hold until the buzzer beeps.)
Self-Test		<ul style="list-style-type: none"> a. Commands the UPS to perform self-testing (Press and hold until the buzzer beeps.) b. Battery and Load Display Function Mode (Do not hold for > 1 second.)
© Manual Bypass		Press the "ON" key and "Self-Test" key simultaneously for three seconds to transfer from "Inverter to Bypass" (The bypass LED will continuously blink and the buzzer will beep intermittently.) or "Bypass to Inverter" when the UPS is in on-line mode and the Bypass Voltage Window is Normal.

LED Indicator	Symbol	Description
Normal Mode LED		<ol style="list-style-type: none"> 1. Solid indicates normal utility voltage. Blinking indicates insufficient utility voltage for the full load. Off indicates abnormal utility voltage. 2. In Battery and Load Function Mode indicates battery capacity is 50%.
Battery Mode LED		<ol style="list-style-type: none"> 1. Indicates load supplied by battery power. 2. In Battery and Load Function Mode indicates battery capacity is 25%.
Bypass Mode LED		<ol style="list-style-type: none"> 1. Indicates load supplied by bypass. 2. In Battery and Load Function Mode indicates battery capacity is 75%.
Battery Bad/Weak LED		<ol style="list-style-type: none"> 1. Indicates low battery power or faulty battery bank. 2. In Battery and Load Function Mode indicates battery capacity is 100%.
Fault LED		<ol style="list-style-type: none"> 1. Solid indicates fault or abnormal condition. 2. Blinking indicates LED Panel in Error Code Function Mode.
Overload LED		<ol style="list-style-type: none"> 1. Indicates UPS is overloaded. 2. In Error Code Function Mode indicates Error Code 16.
Site wiring fault LED		<ol style="list-style-type: none"> 1. Indicates live and neutral lines are connected wrongly or high neutral-ground voltage. 2. In Battery and Load Function Mode indicates load capacity is 100%. 3. In Error Code Function Mode indicates Error Code 8.
Outlet1 LED		<ol style="list-style-type: none"> 1. Indicates UPS Outlets 1 are enabled and ready to supply loads. (This function is optional.) 2. In Battery and Load Function Mode indicates load capacity is 75%. 3. In Error Code Function Mode indicates Error Code 4.
Load LED	Load	<ol style="list-style-type: none"> 1. Indicates UPS outlets are enabled and ready to supply loads. 2. In Battery and Load Function Mode indicates load capacity is 50%. 3. In Error Code Function Mode indicates Error Code 2.
Outlet2 LED		<ol style="list-style-type: none"> 1. Indicates UPS Outlets 2 are enabled and ready to supply loads. (This function is optional.) 2. In Battery and Load Function Mode indicates load capacity is 25%. 3. In Error Code Function Mode indicates Error Code 1.

3.1.2 ARES RT< Convertible Type (Rack / Tower)> LCD panel











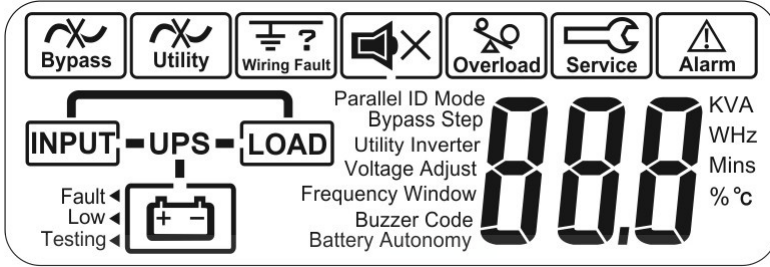





Item	Sign	Description
①		LCD Display
②		Green LED steadily lights up to indicate that the Utility input voltage is within the window (160Vac~288Vac); the LED flashes flickeringly to indicate that the Utility input voltage is within the acceptable window (120Vac~159Vac).
③④		Green LED lights up to indicate there is an output available at the Programmable Outlet 1 & Programmable Outlet 2.
⑤		Amber LED lights up to indicate the Bypass Input is normal.
⑥		UPS Fault LED
⑦		UPS On/Alarm Silence

⑧		UPS OFF Switch
⑨		Special functions log in/out
⑩		Go to next page
⑪		Go to previous page or change the setting of the UPS.
⑫		To re-confirm the change of UPS Setting

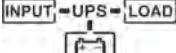
© Manual Bypass : Press "⑦ ON-KEY" and "⑪ Up-KEY" key simultaneously for approx. 3 seconds to transfer from "Inverter to Bypass" (the bypass led continuously "blink" and the buzzer will beep intermediately or "Bypass to Inverter", when the UPS is on Line Mode and the Bypass Voltage Window is Normal.

3.1.3 LCD displayer description



Item	Sign	Description
1		Bypass Input Abnormal, UPS fails to transfer to bypass, Bypass Abnormal at ECO mode
2		Utility Input Abnormal
3		Site Wiring Fault
4		Buzzer Silent
5		UPS Overloading
6		UPS Working in specified mode*
7		UPS Fault or Abnormal Warning
8		UPS Flow Chart
9		3-Digit Measurement Display
10		Indicates the item to be measured
11		Battery Abnormal
12		Battery Low
13		Testing

3.2 Rear Panel

ARES RT 230V

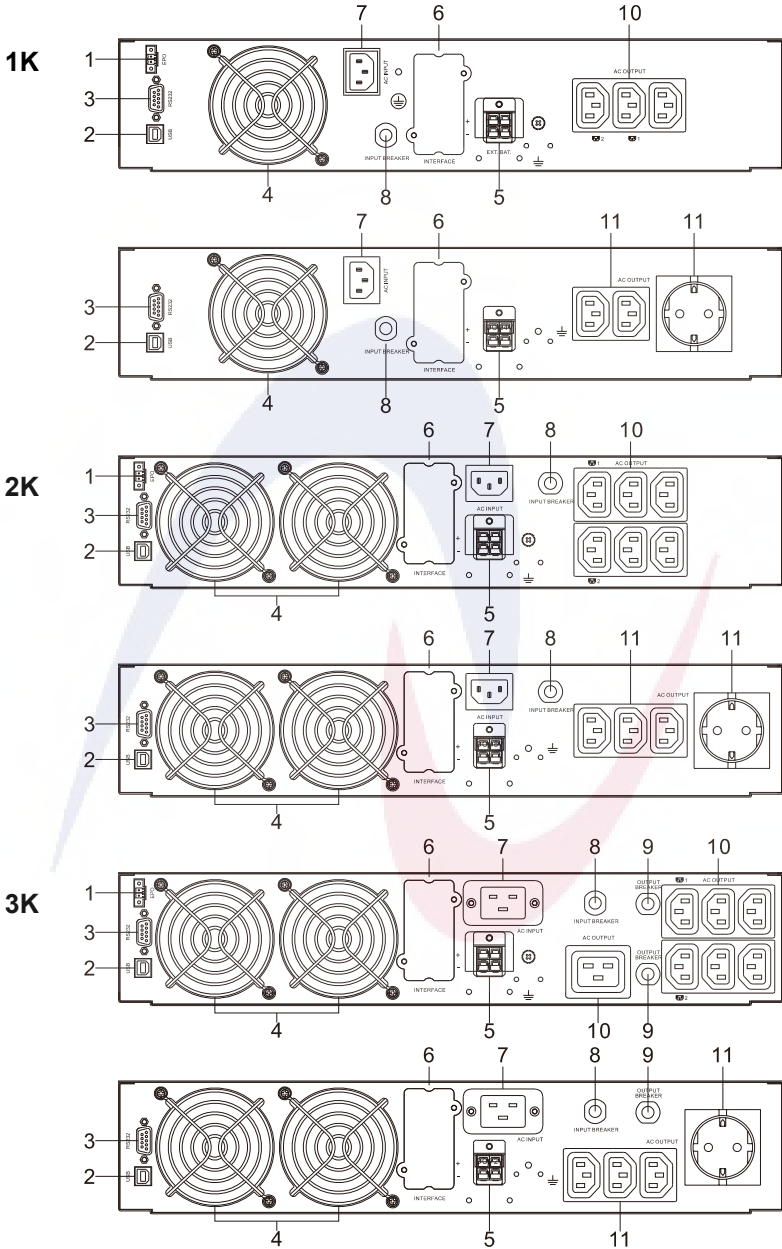

1. Emergency Power Off (EPO) / Remote ON/OFF (ROO)
Dry contact signal inputs
2. USB port*
3. RS-232 port
4. Fan
5. External battery connector*
6. Slot for optional communication cards*
7. AC power connection socket
8. Utility input circuit breaker
9. Output circuit breaker for two outlets
10. AC outlets(Program Relay*)
11. AC outlet

* Remark: Optional function



3.3 Communication Port Explanation

The UPS is equipped with a true RS-232 communication port as standard to provide communication with bundled UPS monitoring software for remote monitoring of the UPS status using a PC.

In addition, there are six optional interface cards available to meet various communication needs: USB, EPO, DCE (dry contact relay card), R2E, USE, and an SNMP/Web card. (Please see Chapter 8.)

The software bundled with the UPS is compatible with many operating systems, including Windows 98 / Me / NT / 2000 / 2003 / XP / Vista / 2008 / 7 / 8 , Novell, NetWare, Unix, Linux 2.6.x, Mac OS X v10.5 Leopard, Mac OS X v10.6 Snow Leopard please contact your local dealer for suitable software.

All communication ports including optional cards can be active and used simultaneously to monitor the UPS status. However, only one communication interface at a time (the one with the highest priority) can control the UPS. The priorities of these communication interfaces are as follows (highest priority first).

- 1) EPO/ROO input port
- 2) Optional interface card
- 3) Optional USB
- 4) RS-232

3.3.1 True RS-232

The RS-232 interface must be configured as follows.

Baud Rate	2400 bps
Data Length	8 bits
Stop Bit	1
Parity	None

Pin Assignments:

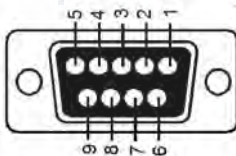

- Pin 3: RS-232 Rx
- Pin 2: RS-232 Tx
- Pin 5: Ground

3.3.2 EPO

Pin Assignments:

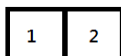

+ Gnd

Function setting :

1. EPO NC → Shutdown UPS (default)
2. EPO NO → Shutdown UPS
3. ROO NC → Start-up UPS
4. ROO NO → Start-up UPS

(this function setting by setting tool)

4. Installation and Operation

Please read the Safety Instruction guide (pages 2 and 3) before installing the UPS.

4.1 Unpacking

Inspect the UPS upon receipt. The packaging is robust, but accidents and damage may still occur during shipment. Notify the forwarder and dealer if there is damage.

The packaging is recyclable and reusable.

1. After removing the packing foam please be careful handling the UPS while it is still in the plastic bag. The plastic is slippery, and the UPS could fall and injure your feet.
2. Check for the following standard package contents, in addition to the UPS itself.

A. User Manual

B. IEC output cables (for UPS with IEC sockets only)

C. IEC input cables (for UPS with IEC sockets only)

A1



x4

B1



x2

B2



x2

S1



M3x6mm

x8

S2



M3x6mm

x8

S3



M4x8mm

x6

C1

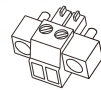

x1

4.1.1 Installation Instructions

Tower installation

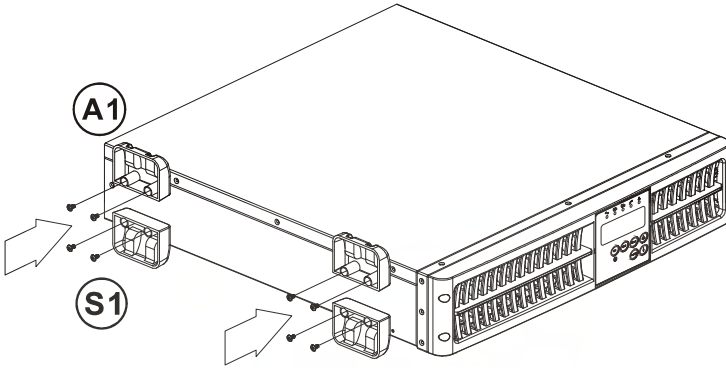

Rack Mount installation

Step 1

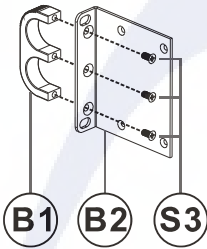

Step 2

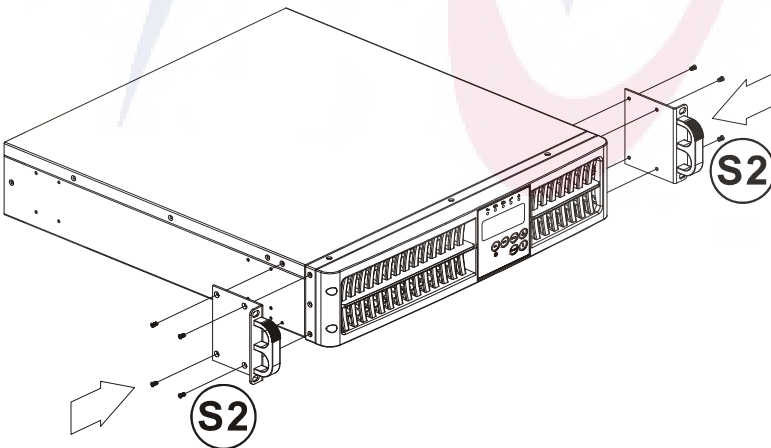

Step 3

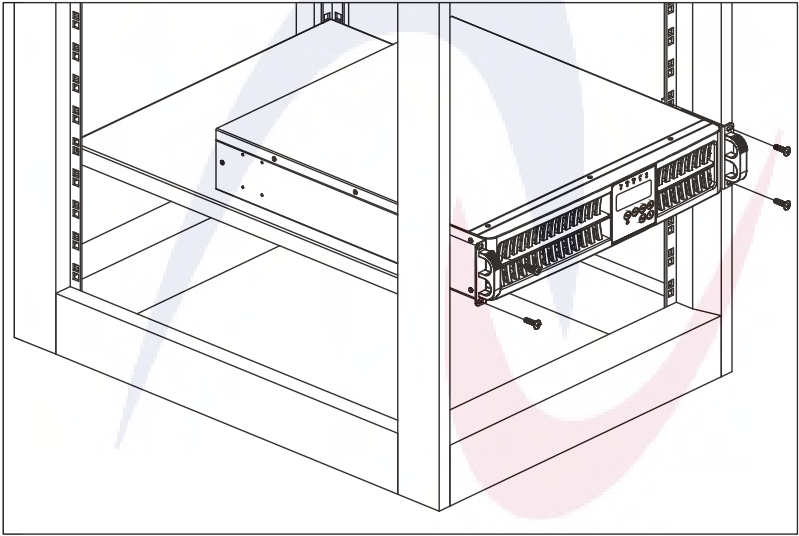
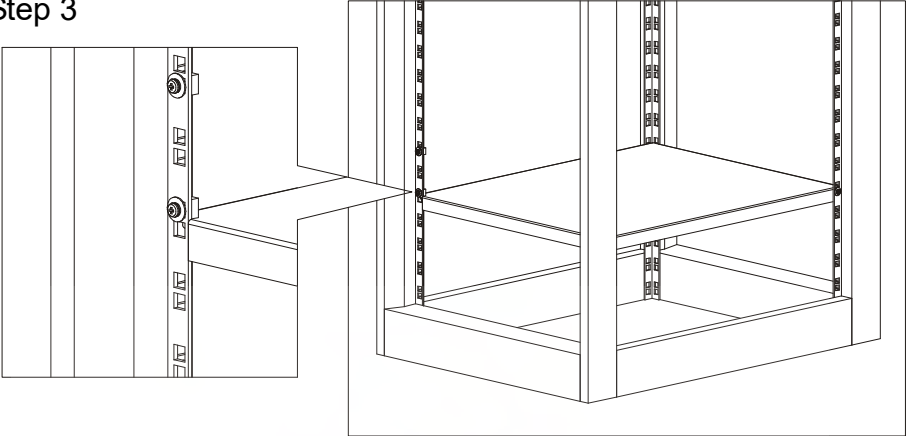

4.2 Selecting Installation Position

The UPS is heavy. Select a location sturdy enough to support the UPS weight.

To ensure proper operation and long operating life, position the UPS according to the following requirements.

1. Keep at least 20 cm (8 inches) of clearance beyond the rear panel of the UPS.
2. Do not block the air flow to the ventilation louvers of the unit.
3. Ensure that the installation site is free from excessive dust and the ambient temperature and humidity are within the specified limits.
4. Do not place the UPS in a dusty or corrosive environment or near any flammable objects.
5. This UPS is not designed for outdoor use.

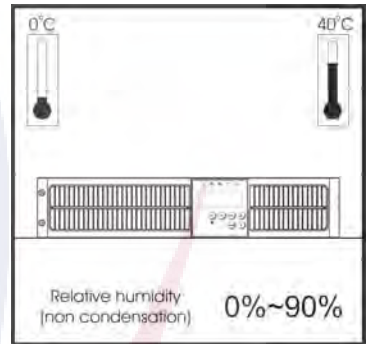
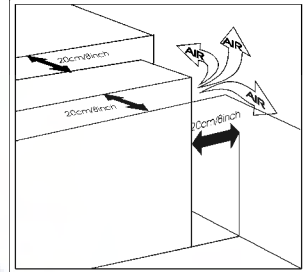







4.3 Operation

4.3.1 Using the standard LED panel

4.3.1.1 Start Up in Normal AC Mode

1. Before commencing ensure that the grounding is connected properly.
2. Ensure that the utility voltage matches the input voltage window of the UPS.
3. Connect the UPS main power cord into the utility AC power source receptacle.
4. Switch on the AC power source. All of the LEDs on the front panel display will flash once after five seconds. At the same time, the fan at the front of the UPS will start operating.







5. Press and hold the ON button '  ' for approximately one second to start the UPS. The buzzer will beep and the LED indicators "  ", "  ", "  " and "Load" will shine after 1-5 seconds. The start-up procedure is now completed, and the UPS outlets are ready to supply power to the load.
6. It is advisable to perform a battery mode test before connecting the loads to the UPS to ensure that the batteries are working properly. To do this, switch off the AC power source when the UPS is on. The  LED on the front panel display will turn off, the  LED will shine, and the buzzer will pulsate, indicating that the UPS is in Battery Mode. Connect a non-critical load to the UPS outlets to confirm that the batteries are supplying power. Repeat the test by switching on and off the AC power source to ensure that the UPS is functioning properly.

4.3.1.2 Start-up in Battery Mode (Cold Start)

This UPS can be switched on without the presence of an AC power source.



Press and hold the ON button '  ' until the buzzer beeps. Release and then within the next 10 seconds press and hold the same button a second time. The UPS will perform its start-up procedure. The LEDs "  ", "  ", "  " and "Load" will shine after 1-5 seconds, and the buzzer will pulsate to indicate successful power-on.

Note: Ensure that the UPS batteries are pre-charged for at least four hours by simply connecting the AC power cord to the utility receptacle.

4.3.1.3 Shutdown

1. Shutdown in AC Mode

Press and hold the OFF button , for five seconds until the buzzer beeps. The UPS will cut the power supply to the outlets. The ventilating fans will continue to operate. Switch off the AC power source. The ventilating fans will stop. The UPS is now completely shut down.





2. Shutdown in DC Mode

Press and hold the OFF button , for five seconds until the buzzer beeps. The UPS will cut the power supply to the outlets. The LEDs will turn off, and the ventilating fans will stop after ten seconds and the \pm BUS discharge is below 42 V. The UPS is now completely shut down.

4.3.1.4 Self Testing in AC Mode

After the UPS has been successfully started in AC mode, press and



hold the Self-Test button  for five seconds until the buzzer beeps. The  LED will shine to indicate that the self-test is in progress. When the self-test is completed the UPS will return to AC mode. If there were no faults or abnormal conditions then the LED indicators  and  LEDs will turn off.



Note: The main function of self testing is to run a discharge test on the batteries.

4.3.2 LCD Panel

4.3.2.1 Line mode start up

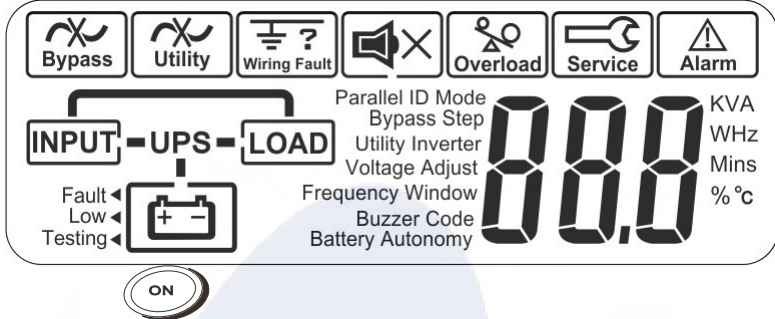

1. Please ensure the outlet of power source is proper grounded.
2. Ensure the voltage rating of power source is matched with UPS spec.
3. Plug in UPS to the AC source
4. UPS will start initializing after AC input power is available 5 seconds. LED/LCD indicator will be all lit and dim once and fan will start spinning. Full LCD display looks as below figure:



5. Press UPS  button and hold until twice beep heard, UPS begins starting procedures for 5 seconds. LCD display will show as below figure-A and then figure-B sequentially. LEDs  will light up to indicate that the Utility and the Bypass are normal. And then "⌚", "U1", "U2" LED remain lit during figure-B LCD display.



When you see figure-B means the starting up procedure is finished. Please ensure UPS recharge in line mode for at least 4 hours for fully recharged before the first backup test if it's a new installed unit.

- Back up test – Unplug inlet power cord or switch off power source to simulate power failure condition. Green LED indicator  will be dimmed and Amber LED "" " will be light. Intermittent audible alarm will be heard and LCD display shows as below figure-C:

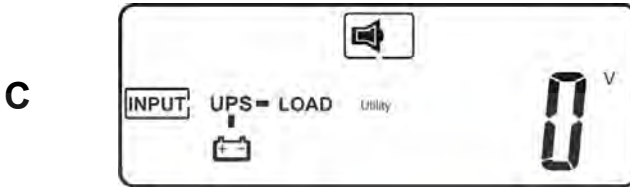



4.3.2.2 Cold Start (DC start)

- Ensure the internal battery is available or external battery set well

connected to UPS. Press and hold  key for 3 seconds

until twice beeps heard, release button and press  for 3 seconds until twice beeps heard again to confirm cold start procedure. If the 2nd button confirmation not be finished within 10 seconds after 1st twice beeps, UPS will not cold start and shut off after 10 seconds.

- 5 seconds after cold starting, amber LED "" " will be light, intermittent audible alarm will be heard and LCD will show sequentially as below figure-D and figure-E

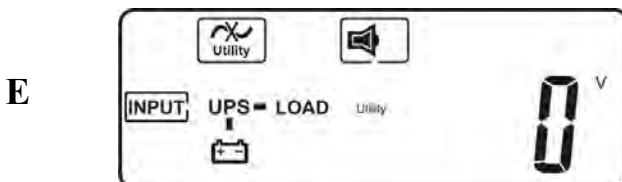
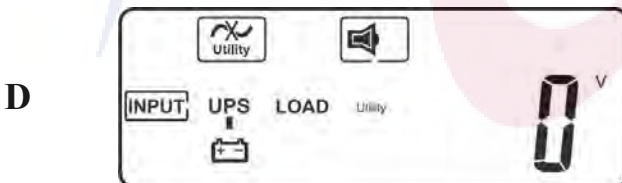

4.3.2.3 Operation of measurements display

1. UPS measurements can be checked after UPS started by pressing



select key . The display sequence are as below figure-F (AC input voltage)→figure-G (AC input frequency)→figure-H (UPS output voltage)→figure-I (UPS output frequency)→figure-J (UPS loading percentage)→figure-K (UPS output current)→figure-L (Battery voltage) →figure-M (UPS inner temperature) and back to figure-F.

F

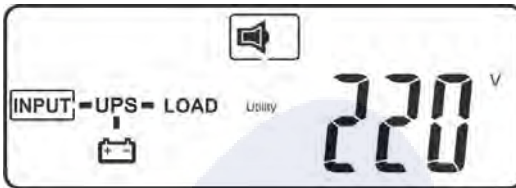

G



H

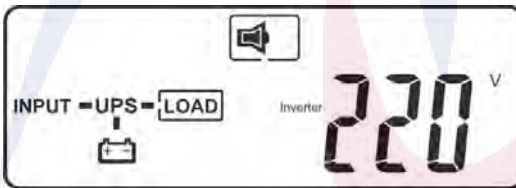

I

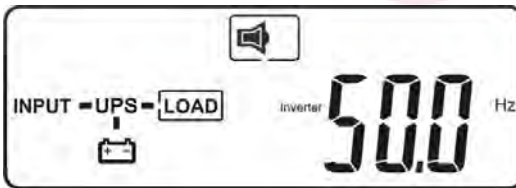

J

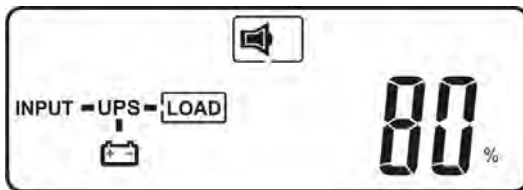

K

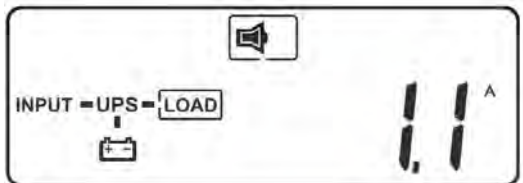

L

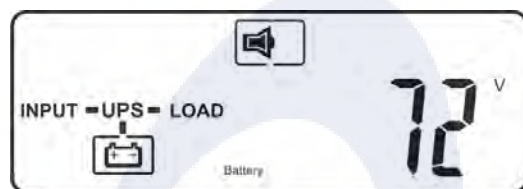

M

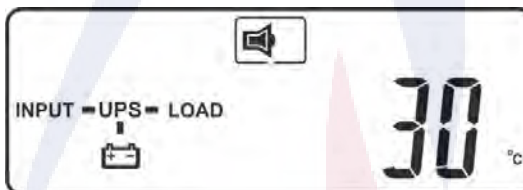

4.3.2.4 UPS Locked up

UPS may lock itself up while there was critical abnormal or failure condition happened. User may see LCD display as below figure-N.

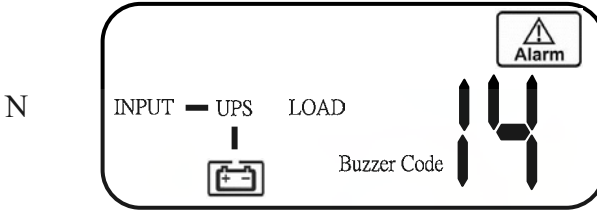

The procedures to release UPS from locked up status are as below:

- (a) Check and record the error code.
- (b) Check user's manual to understand possible cause, solve the problem or call service provider.
- (c) Press OFF key  and hold for 5 seconds until twice beep heard.
- (d) Unplug AC input power cord or turn off power source switch.
- (e) After UPS completely shut off, UPS is unlocked.

4.3.2.5 UPS Default Data and Special Function Execution

After the UPS completely starts up, press the  key to change the LCD display to figure Q1.



Q1

buzzer "On"

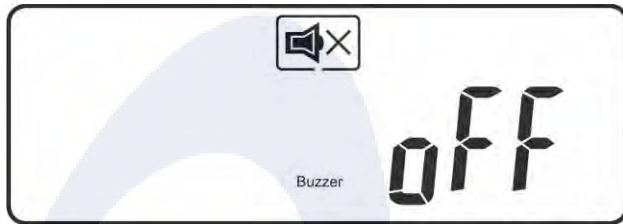

Q2

buzzer "Off"

4.3.2.6 Press the  key to scroll through the UPS settings. The LCD will display in sequence figure Q1 (buzzer) → figure R1 (Self-test) → figure S1 (Bypass Voltage Windows) → figure T (Output Frequency Synchronization Window) → figure U (Inverter Output Voltage) → figure V1 (UPS Operation Mode) → figure W (Output Voltage Micro Tune Value) → figure X (UPS Id) → figure Y (Parallel function status).

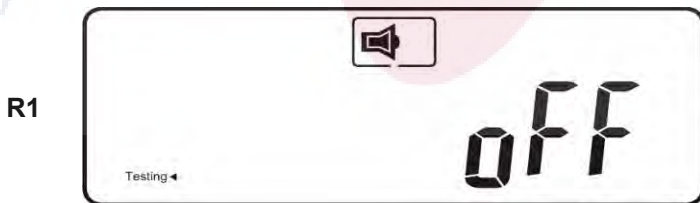

R1

Self-test is not "On".

R2

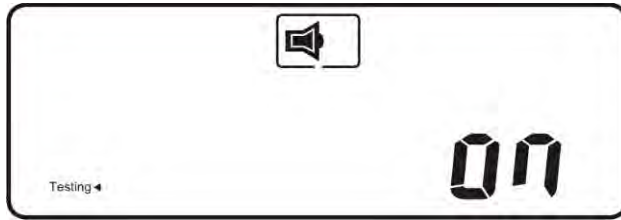

Self-test is "On".

S1

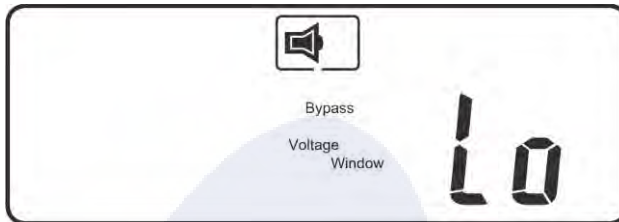

Bypass Voltage is adjusted to wide range.

S2

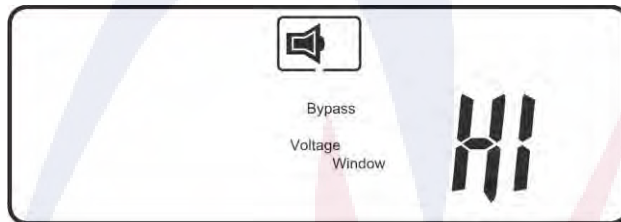

Bypass Voltage is adjusted to narrow range.

T

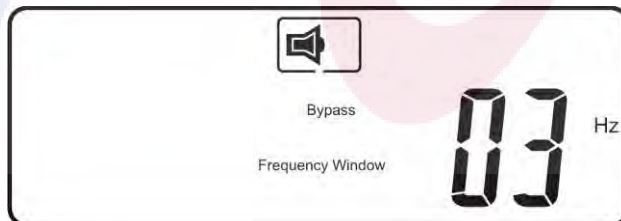

Frequency Window is +/-3 Hz.

U

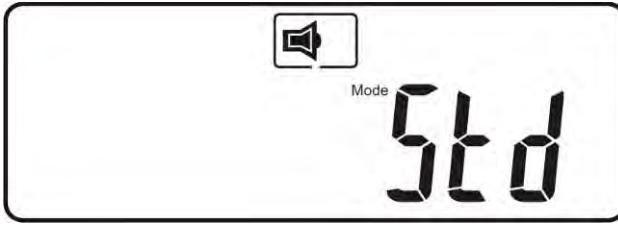

inverter output voltage

V1

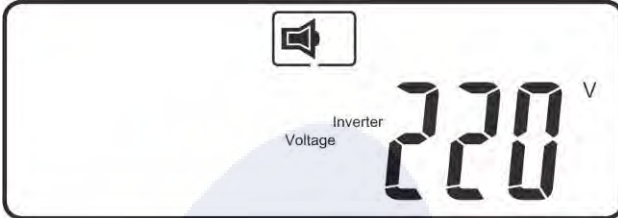

The UPS is operating in "normal mode".

V2

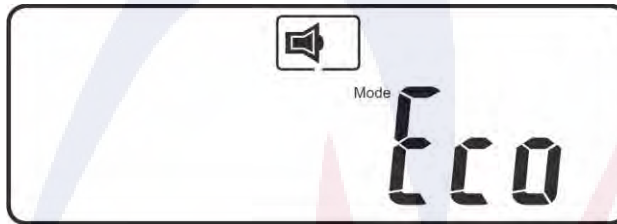

The UPS is operating in "Eco mode".

V3

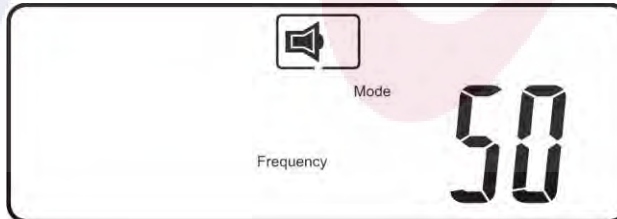

The UPS is operating in "CVCF 50 Hz mode".

V4

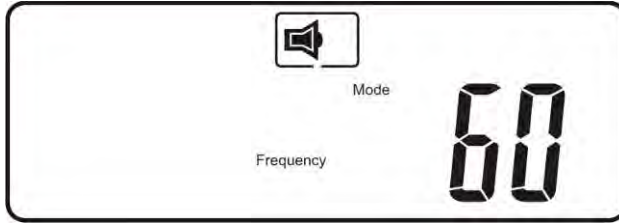

The UPS is operating in "CVCF 60 Hz mode".

W

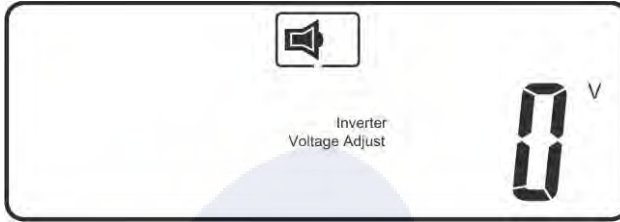

Output Voltage Adjustment (-6.0V ~ +6.0V)

4.3.2.7 Press the scroll up  key to execute special functions. The functions include buzzer ON (as in figure Q1), buzzer OFF (as in figure Q2, Alarm silence for UPS Warning), and self-test OFF (as in figure R1) or self-test ON (as in figure R2). The UPS will execute the battery test for ten seconds.

4.3.3 UPS Default Settings and their alternatives



4.3.3.1 Make sure the UPS is not "On". Press the On  and scroll

down  keys simultaneously for approximately three seconds. The buzzer will sound twice, and the LCD will display figure Q1, indicating that the UPS is in setting mode.

4.3.3.2 To scroll through the options refer to section 4.3.2.6.

4.3.3.3 Except for Buzzer (figures Q1 and Q2) and Self-test (figures R1 and R2) all of the other default settings may be changed by pressing the

scroll up  key.

4.3.3.4 Figures S1 and S2 indicate the bypass input acceptable window. It follows the inverter output voltage. Please refer specification for the detail.

4.3.3.5 Figure T indicates the bypass frequency window of the Inverter Output. The acceptable setting values are ± 3 Hz and ± 1 Hz.

4.3.3.6 Figure U indicates the acceptable Inverter Output Voltage. Possible values are 200, 208, 220, 230, or 240 VAC.

4.3.3.7 Figures V1, V2, V3 and V4 indicate the operation modes of the UPS. Possible values are Online, Eco (Economical) mode, fixed 50 Hz Output, and fixed 60 Hz Output.

4.3.3.8 Figure W indicates the adjustment of the Inverter Output, which may be set to 0%, +1%, -1%, +2%, -2%, +3%, or -3%.

4.3.3.9 After changing settings you must scroll to the "End" screen (figure X)

and then press the enter  key to save all of your changes.





* Press the Enter key to save changes.

4.3.3.10 Turn Off the Utility Input breaker.



4.3.3.11 Your setting changes are now complete.

4.3.3.12 Turn UPS off

- (1) Line mode(AC input available) : Press Off key  and hold until twice beeps heard, UPS output will shut off. UPS will stay in standby mode, fan(s) keep spinning and battery will be remained recharging if AC input still available after output is off, otherwise it will be shutdown completely.
- (2) Backup mode (AC input not available): Press Off key  and hold until twice beeps heard, UPS output will shut off. 10 seconds later, fan stop spinning and UPS shutdown completely.

4.3.3.13 Self-Test (Line mode only)

The purpose of self-test function is to ensure the backup capability of battery set, and it can only be applied when UPS is working under line mode (AC input available) and battery set was proper recharged.

Press  →  key to change the LCD display to below figure.



And press  key to start Self-test as below figure

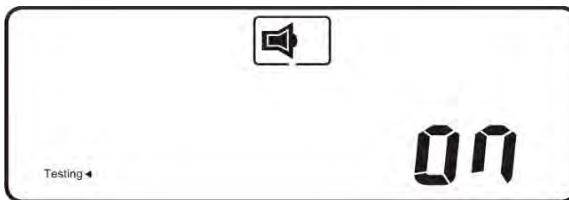

If UPS transfer to backup mode for 10sec and transfer back to

line mode operation without any code or alarm, means the battery set is healthy, otherwise UPS may give code to indicate the cause of failure.

4.3.4 Beep Codes

The following table contains common UPS statuses with their beep codes.

UPS Status	Beep Code
UPS faulty, Inverter shut down. All functions inhibited.	Long Continuous Beep
Control keypad error	Long Continuous Beep
UPS faulty, loads continue to be supplied via Inverter or Bypass.	Single beep every two seconds
In battery mode	Single beep once per second
Battery low	Quick and short successive beeps
Confirm RS-232 port receiving	two quick and short beeps
Service mode okay	one quick and short beep

5. UPS System Block Diagram

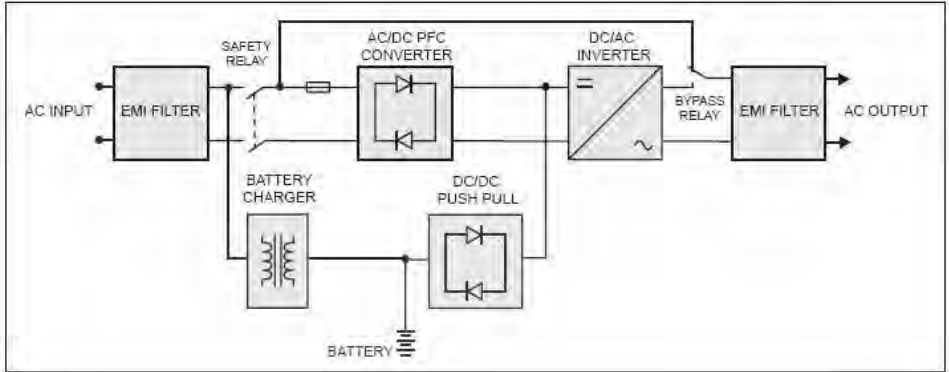











Figure 4.1

Figure 4.1 illustrates the True On-Line Double Conversion architecture of the UPS system. The major modules consist of:

- 1) An AC-to-DC power converter (rectifier) with PFC control circuit
- 2) A DC-to-AC high frequency inverter
- 3) An intelligent battery charger
- 4) A bank of stationary, maintenance-free batteries
- 5) A DC-to-DC push/pull converter control circuit
- 6) A static bypass loop
- 7) Input and output EMI filters





The table below provides a summary of the UPS operating modes under various utility AC power source and battery conditions.

Utility Condition	UPS Operating Mode	LEDs
Normal	Working power starts after approximately 5 seconds, LEDs on the panel will blink and fans will start. Press the ON button  for 1-5 seconds. The UPS starts up normally.	 ,  ,  and Load LEDs remain lit
Abnormal (under or over voltage or absent)	Rectifier and charger stop operating. Battery discharges via DC-DC boost circuit and supplies Inverter. Loads continue to receive supply from Inverter. Alarm buzzer beeps. UPS now in battery mode.	 LED off,  LED illuminated
Utility abnormal or absent, or battery voltage low	Rectifier and charger stop operating. Battery discharges via DC-DC boost circuit and supplies Inverter. Alarm buzzer beeps quickly, indicating battery power low and Inverter may stop supplying soon.	 LED off,  and  LEDs illuminated

6. Maintenance Guide



6.1 Troubleshooting

If the UPS malfunctions during operation please check that all lines are connected properly and that the utility specifications are correct. Then check the table below for solutions. Should the problem persist please contact your local dealer for assistance.

Situation	Check Items	Solution
Fault  LED Read the error code (see next page) displayed by the combination of LEDs, and verify the fault as follows.	1. Er05,Er39 	1. Check for proper battery connection. Measure battery voltage to ensure that batteries are charged and healthy. Recharge batteries for 8 hours if necessary. Simulate utility outage to verify that UPS is able to provide DC backup. Otherwise consult your local dealer right away.
	2. Overload 	2. Disconnect some non-critical loads from the UPS output until the overload ceases. Check if there is any short circuit between cables due to broken cable insulation. Replace the cables if necessary.
	3. Er11 (UPS Over Temperature)	3. Remove any objects obstructing the ventilation louvers. Verify that the cooling fans are working properly. Contact your local dealer to replace the fans if necessary.
	4. Site wiring/Ground fault  ?	4. Check if the “L” and “N” phases of the utility AC source have been wrongly wired or if the Ground-Neutral voltage exceeds the limits.
	5. Er14 (Fans out of order)	5. Verify that the ventilating fans are functioning properly. Do not attempt to replace the fans yourself. Contact your local dealer for replacement.

	6.Other error codes	6. Consult your local dealer for assistance.
UPS fails to provide battery backup or its backup time is shorter than its intended performance.		If the backup time remains unsatisfactory after 8 hours of charging please contact your local dealer for battery replacement.
UPS is normal, but there is no output to the load.	Check that all power cords are properly connected.	If the problem persists consult your local dealer for technical assistance.
The UPS switches into battery mode and then back into utility mode when a connected device is turned on, or the UPS switches back and forth between battery and utility modes.	1. A power strip is connected to the UPS. See if there is any damage to the utility wall receptacle or if the cord plug is faulty.	1.Do not use the power strip. 2.Replace the wall receptacle/cord plug.
Strange noise or smell		Immediately shut down the whole system. Disconnect the power from the UPS and call for service.
UPS is unable to provide backup power.		Check that the battery connectors are fully engaged. Allow the batteries to recharge if they are weak. If the problem persists after recharging replace the batteries. If the problem still persists consult your local dealer for technical assistance.

Error Codes

When the Fault LED  is lit press the ON button , briefly to check the error code. The error codes 1, 2, 4, 8, and 16 are represented by the four bar LEDs 25%, 50%, 75%, and 100%, and the Overload LED . Each LED represents a number as shown in the figure below. For example, the figure below shows the 25%, 50%, and 100% bar LEDs lit. The error code is therefore $8 + 2 + 1 = 11$, or Er11, which indicates that the UPS is over-temperature.

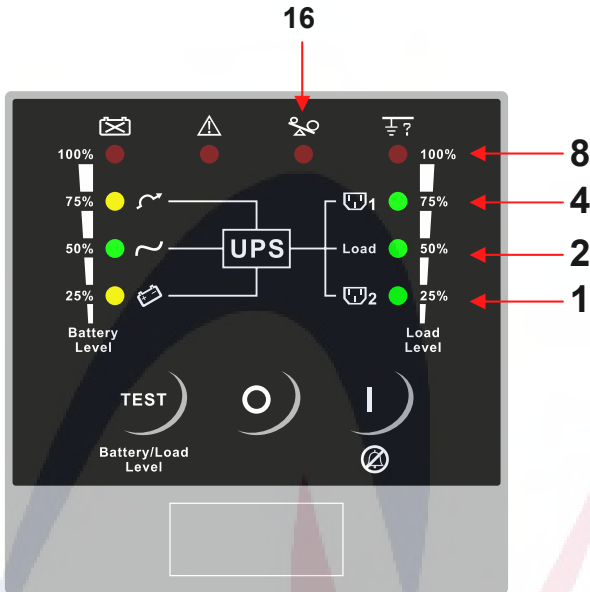

Checking error code on LCD panel :

If UPS is in abnormal condition , common alarm sign  will light up and come with audible alarm. The LCD screen will shows information of alternate normal and error code. You can follow section 6.1 and 6.2 up for troubleshooting.

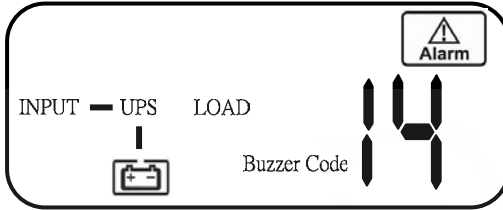

6.2 Error Codes and Their Meanings

Code	Meaning
Er05	Battery weak or faulty
Er06	Output short-circuited
Er07	EPO mode
Er11	UPS over-temperature
Er12	Inverter overload
Er14	Fan errors
Er39	When UPS start process, Utility Voltage less than 160V and Battery no connection.
Er28	Bypass overload

6.3 Maintenance

1. Clean the dust from the ventilation openings and intakes on the rear panel.
2. Turn off the UPS and wipe the casing with a damp cloth. Be careful to avoid getting water in the UPS.
3. Periodically unplug the power cord of the UPS from the wall receptacle to test the condition of the batteries. Be sure you have saved your data in any open computer applications before you proceed with this battery test.

7. Communication Software

7.1 Hardware Setup

1. Decide whether to use RS-232 communication or USB communication. (For optional interface cards please refer to Chapter 8.)
2. Connect a male RS-232 connector or a USB cable* to the UPS communication port. Connect the female RS-232 connector or the other end of the USB cable to the computer.

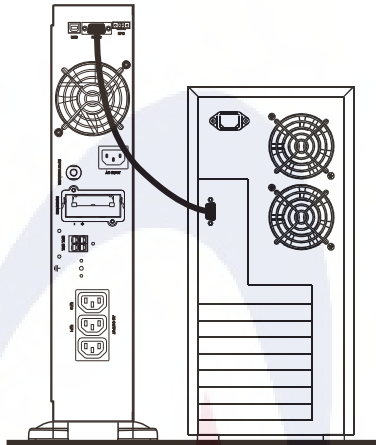

***Note: RS-232 and USB cables are optional.**

7.2 Software Installation

Please refer to the software user's manual.

8. Optional Communication Cards

8.1 R2E (second RS-232) card

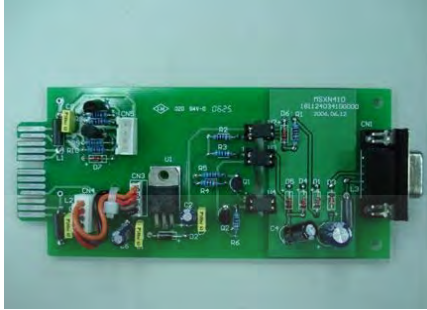

8.1.1 CN1 is for RS-232 DB9.

8.1.2 For interface settings and pin assignments please refer to section 3.3.1.

8.1.3 Installation Position: Optional Slot

8.2 USE (USB) card



8.2.1 CN1 is for USB.

8.2.2 For the communication protocol definition please refer to section 8.4.2.

8.2.3 Installation Position: Optional Slot

8.3 DCE (Dry Contact) card

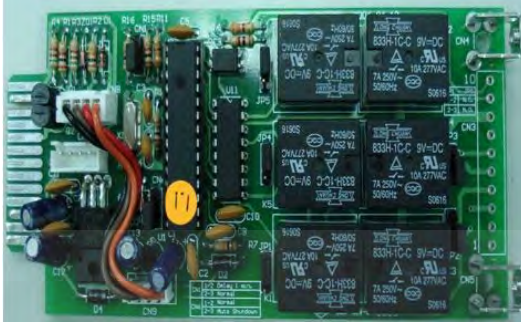

8.3.1 Pin assignments of 10-Pin terminal:

1	2	3	4	4	5	6	7	8	9	10
---	---	---	---	---	---	---	---	---	---	----

- 1 → UPS in Bypass mode (Bypass)
- 2 → Utility Abnormal (normally closed contact)
- 3 → Utility Normal (normally open contact)
- 4 → Inverter On
- 5 → Battery Low
- 6 → Battery Bad or Abnormal
- 7 → UPS Alarm
- 8 → Common
- 9 → Shutdown UPS positive (+) signal
- 10 → Shutdown UPS negative (-) signal

8.3.2 The shutdown function will be activated after +6-25 VDC is applied between pin 9 and pin 10 for 5 seconds.

8.3.3 The capacity of each relay contact is 40 VDC/25 mA.

8.3.4 Installation Position: Optional Slot

8.3.5 Flexible signal output for N.C. (Normally Closed) or N.O. (Normally Open) contact by shorting pins 1-2 or pins 2-3 from JP1-5

8.3.6 The shutdown function will be enabled 1 minute after blackout occurs if pins 1-2 of both CN1 and CN6 are shorted. Otherwise the shutdown function can be enabled only by pins 9-10 of CN3 if pins 2-3 of both CN1 and CN6 are shorted.

8.4 SNMP Cards

8.4.1 Megatec SNMP card



8.4.1.1 For installation please refer to the user's manual that came with the card.

8.4.1.2 Installation Position: Optional slot on rear panel

8.4.2 USB

The USB communication protocol definition is as below.

1. Complies with USB version 1.0, 1.5 Mbps.
2. Complies with USB HID version 1.0.
3. Pin Assignments:

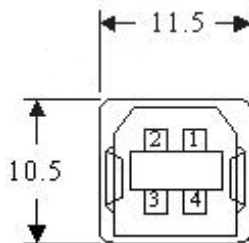

- 1 → VCC (+5V)
- 2 → D-
- 3 → D+
- 4 → Ground

9. Specifications Convertible Type (Rack / Tower)

MODEL	ITEM	ARES RT-1K	ARES RT-2K	ARES RT-3K
CAPACITY	VA	1000 VA	2000 VA	3000 VA
	W	when input voltage is 180~300Vac PF=0.9 (900/ 1800/ 2700W)		
INPUT	Voltage Rating	110/150/180~300 VAC (Based on load percentage 0 ~ 60% / 0 ~ 75% / 0 ~ 100%)		
	Frequency Rating	50Hz 60Hz	44-66 Hz fin> 44Hz and fin < 56Hz fin> 54Hz and fin < 66Hz	
	Phase	Single phase with ground		
	Power Factor	≥ 0.99 (with full linear load)		
	Generator Input	Supported		
	Input Cable 1.8 m.	10 A, IEC 320-C14	10 A, IEC 320-C14	16 A, IEC 320-C20
Output	Voltage	230 V, adjustable to 200/208/220/230/240		
	Voltage Regulation	within ±1% until low-battery warning		
	Frequency (Synchronized Range)	3 Hz or 1 Hz (selectable)		
	Frequency (Battery Mode)	50/60 Hz ±0.2% unless synchronized to line		
	Current Crest Ratio	3:1		
	Harmonic Distortion	< 2% at full linear load < 5% at full non-linear load		
	Output Waveform	Pure sine wave		
	Outlets	(3) 10 A, IEC 320-C13	(6) 10 A, IEC 320-C13	(6) 10A, IEC 320-C13 + (1) 16A IEC 320-C19
	Overload Capacity (tolerance±1%)	Line Mode: < 105%continuous 106-120% for 30 seconds transfer to bypass. 121-150% for 10 seconds transfer to bypass. > 150% Immediately transfer to bypass. Buzzer continuously alarms.		
		Battery Mode : < 105% continuous 106-120% for 30 seconds shuts down 121-150% for 10 seconds shuts down > 150% Immediately shuts down. Buzzer continuously alarms.		

		<p>Bypass Mode :</p> <p>< 105% continuous 106-120% for 250 seconds shuts down 121-130% for 125 seconds shuts down 131-135% for 50 seconds shuts down 136-145% for 20 seconds shuts down 146-148% for 5 seconds shuts down 149-157% for 2 seconds shuts down 158-176% for 1 seconds shuts down 177-187% for 0.32 seconds shuts down > 188%for 0.16 seconds shuts down. Buzzer continuously alarms.</p>					
Efficiency (Full Linear Load)	Line mode(Rating 230Vac)	91%		92%		93%	
	Battery mode(12Vdc/pcs)	90%		91%		92.5%	
	ECO mode(Rating 230Vac)	97%		98%		98%	
Battery (Sealed, non-spillage, maintenance-free, lead acid)	Number of batteries	2	3	4	6	6	
	Battery type	12 V/ 7.2 Ah				12 V/ 9 Ah	
	Rated Battery Voltage	24 V	36V	48 V	72V	72 V	
	Backup time (Linear Load)	50% Load	> 13	>14'	> 13	> 14	> 14
		70% Load	> 8 min	>9 min	> 8	> 9	> 8
100%Load		> 5 min	> 6 min	> 5 min	> 6 min	> 5 min	
Charger	Charge Current (Max.)	Standard	1.6A	2.1A	1.5A	1.5A	
	Supplementary Charger (Max.)	(Optional)	5A x 1	5A x 1	5A x 2	4A x 2	
	Recharge time (to 90%)	2~4hr		2~4hr		2~4hr	
	Floating Mode Charging Voltage	27.3V±1%	40.9V±1%	54.6V±1%	81.9V±1%	81.9Vdc±1%	
	Bluk Mode Charging Voltage	28.2V±1%	42.3V±1%	56.4V±1%	84.6V±1%	84.6Vdc±1%	
	DC leakage current	≤ 30 μA with no AC applied and the unit in the off position					
Transfer time	AC to DC	0 ms					
	Inverter to Bypass	4ms(Typical)		4ms(Typical) / 0ms(Optional)			
DC start	Yes						
Self Diagnostics	Upon Power-on, Front Panel Setting & Software Control, 24 hours routine check						
Front Panel	LCD (Standard) LED (Optional)	Normal, Battery, Bypass, Self-Test, Battery Weak & Bad, Site Wiring Fault , Fault, Overload, and Load/Battery Level					
		(Optional) : Programmable Outlet1/ Programmable Outlet2					
	4 Button(Optional)	ON / OFF / Select / Silence					
	6 Button(Standard)	ON(Silence) / OFF / Enter / Function / UP / Down					
Audible Alarm	Battery Mode	Sounds once every 1.5 seconds					
	Low Battery	Sounds once every 0.2 seconds					
	Overload	Sounds once every 3 seconds					

	Normal alarm	Sounds once every 3 seconds			
	Fault	Continuous tone			
Protection	Short Circuit	Bypass mode : Circuit Breaker Normal Mode : Output Breaker/Electronic Circuit Battery Mode : Output Breaker/Electronic Circuit			
	Battery	ABDM			
	EPO	UPS shuts down immediately.			
	Over Temperature	Normal Mode : Transfer to Bypass Mode Battery Mode : UPS shuts down immediately.			
Physical	DimensionsUPS (inches) W x H x D(mm)	17.3 x 3.5 x 15.9 (440 x 88 x 405)	17.3 x 3.5 x 23.6 (440 x 88 x 600)	17.3 x 3.5 x 23.6 (440 x 88 x 600)	
	Weightlbs.(kg)	20.9 lb (9.5kg)	25.8 lb (11.7kg)	38.28 lb (17.4kg)	48.0 lb (21.8kg)
Environmental	Operating Temperature	Operating : 0°C ~ 40°C(32°Fto104°F) Storage : -10°C ~ 50°C(14°Fto122°F)			
	Noise Level	≤46dB			
	Relative Humidity	0-90% (without condensation)			
Interface	Standard	EPO/ROO,RS-232			
	Option	2nd RS232, USB, RS485, Dry Contact Relay, SNMP/WEB Card			
	Compatible Platforms	Microsoft Windows series, Linux, Mac, etc.			
Standards and Certifications	Safety	IEC/EN 62040-1			
	EMC	EN62040-2, EN61000-3-2, EN61000-3-3			
	Markings	CE			

* The UPS Communication software may be downloaded form Ablerex Web-site at:
<http://www.ablerexlatam.com/contact-support>