



User Manual

ARES PLUS-ECO 1~3 kVA

208/220/230/240V Online UPS

This manual contains important instructions that you should follow during installation and maintenance of the UPS and batteries. Please read all instructions before operating the equipment and save this manual for future reference.



Content

Chapter 1 Safety and EMC Instructions.....	4
1.1 Installation	4
1.2 Operation	4
1.3 Maintenance, servicing and faults	5
1.4 Transport	6
1.5 Storage	6
Warning:	6
Chapter 2 Product Introduction.....	7
2.1 Introduction	7
2.2 Product Model List	7
2.3 UPS Outlook	8
2.4 Internal circuit configuration.....	10
Chapter 3 Installation.....	12
3.1 Product inspection	12
3.2 Installation	12
3.3 Wiring	13
Chapter 4 Panel & Operation Guide.....	18
4.1 Display panel.....	18
4.2 UPS Working Mode	28
4.3 Operation.....	29
Chapter 5 Maintenance	31
5.1 Routine Maintain	31
5.2 Battery Maintain	31
Chapter 6 Trouble shooting.....	32
6.1 LCD Warning and Fault Code.....	32
Chapter 7 Specification	33
7.1 Single phase input Tower model Specification.....	33
7.2 Mechanical.....	34
7.3 Environmental.....	34
7.4 EMC & Safety Regulation	34
Warranty	35

Chapter 1 Safety and EMC Instructions

Please carefully read the following user manual and the safety instructions before installing or operating the unit!

1.1 Installation

- ★ See installation instructions before connecting to mains power.
- ★ Condensation may occur if the UPS is moving directly from a cold to a warm environment. The UPS must be absolutely dry before being installation. It is recommended to have an acclimatization time at least two hours.
- ★ Do not install the UPS near water or in damp environment.
- ★ Do not install the UPS where it would be exposed to direct sunlight or near heat.
- ★ Do not connect appliances or items of equipment which would overload the UPS (e.g. laser printers, etc.) to the UPS output.
- ★ Place cables properly to avoid being treaded or tripped.
- ★ Assure to connect with the earth reliably.
- ★ Connect the UPS only to a socket outlet which is earthed shockproof type.
- ★ The building wiring socket outlet (shockproof socket outlet) must be easily accessible to close to the UPS.
- ★ With the installation of the equipment, the sum of the leakage current of the UPS and the connected load does not exceed 3.5mA.
- ★ Do not block ventilation openings on the UPS's housing. Ensure the air vents on the front, side and rear of the UPS are not blocked. Recommended at least 25cm of space on each side. The air flow diagram is shown as below:
- ★ This UPS receives power from more than one source-disconnection of AC source and the DC source is required to de-energize this unit before servicing.
- ★ For PERMANENTLY CONNECTED EQUIPMENT, a readily accessible disconnect device shall be incorporated external to the equipment.
- ★ For PLUGGABLE EQUIPMENT, the socket-outlet shall be installed near the equipment and shall be easily accessible.

1.2 Operation

- ★ For safety consideration, do not disconnect the mains cable on the UPS or the building wiring socket (grounded shockproof socket) during operation, the grounding for the UPS and all loads connected will be disconnected.
- ★ The UPS features its own, internal current source (batteries). You may be electric shocked when you touch the UPS output sockets or output terminal block even if the UPS is not connected to the building wiring socket.
- ★ In order to fully disconnect the UPS, first press the OFF button to turn off the UPS, and then disconnect the mains lead.
- ★ Ensure that no liquid or other external objects can enter the UPS.
- ★ Do not remove the enclosure. This system is to be serviced by qualified service person only. There are NO USER SERVICEABLE PARTS inside the UPS.
- ★ Remove the protective panel only after disconnecting the terminal connections.

1.3 Maintenance, servicing, and faults

- ★ The UPS operates with hazardous voltages. Repairs may be carried out only by qualified maintenance/service person.
- ★ Caution - risk of electric shock. Even after the unit is disconnected from the mains power supply (building wiring socket), components inside the UPS are still connected to the battery which are potentially dangerous.
- ★ Before carrying out any kind of service and/or maintenance, disconnect the batteries. Verify that no current is present and no hazardous voltage exists in the capacitor or BUS capacitor terminals.
- ★ Batteries must be replaced only by qualified person.
- ★ Caution - Risk of Energy hazard, 24/36/48/72V, 7/9AH battery. Before replacing batteries, remove conductive jewelry such as chains, wrist watches, and rings, High energy through conductive material could cause severe burns
- ★ Caution - risk of electric shock. The battery circuit is not isolated from the input voltage. Hazardous voltages may occur between the battery terminals and the ground. Verify that no voltage is present before servicing!
- ★ CAUTION: A battery can present a risk of electrical shock and high short-circuit current. Contact with any part of a grounded battery can result in electrical shock. The following precautions should be observed when working on batteries:
 - a) Remove watches, rings or other metal objects
 - b) Use tools with insulated handles

c) Wear rubber gloves and boots.

d) Do not lay tools or metal parts on top of batteries.

e) Disconnect charging source and load prior to installing or maintaining the battery.

f) Remove battery grounds during installation and maintenance to reduce likelihood of shock. Remove the connection from ground if any part of the battery is determined to be grounded.

- ★ When changing batteries, replace with the same quantity and the same type of batteries.
- ★ Do not attempt to dispose of batteries in a fire. It could cause explosion.
- ★ Do not open or mutilate batteries. released electrolyte is harmful to the skin and eyes. It may be toxic.
- ★ Please replace the fuse only by a fuse of the same type and of the same amperage to avoid fire hazards.
- ★ Do not dismantle the UPS, except the qualified maintenance person.

1.4 Transport

- ★ Please transport the UPS only in the original packaging (to protect against shock and impact).

1.5 Storage

- ★ The UPS must be stockpiled in the room where it is ventilated and dry

Warning:

This is a category C2 UPS product. In a residential environment, this product may cause radio interference, in which case the user may be required to take additional measures.

Chapter 2 Product Introduction

2.1 Introduction

The Ares Plus ECO On-Line-Series is an uninterruptible power supply incorporating double-conversion technology. It provides perfect protection specifically for computer equipment, communication systems and industry control systems.

The double-converter principle eliminates all mains power disturbances. A rectifier converts the alternating current from the socket outlet to direct current. This direct current charges the batteries and powers the inverter.

Because of this DC voltage, the inverter generates a pure sinusoidal AC voltage, which permanently supplies the loads. Computers and periphery are thus powered entirely by the mains voltage. In the event of power failure, the maintenance-free batteries power the inverter. In the event of inverter failure/Overload, UPS transfer to bypass mode, after the failure/overload remove, UPS transfer to inverter mode continue supplies the loads.

This manual covers the UPS listed as follows. Please confirm whether it is the model you intend to purchase by performing a visual inspection of the Model No. on the rear panel of the UPS.

2.2 Product Model List

Product type and Capacity		Model Name	Remark
Standard Model	1KVA	ARPLUS-ECO1002	Tower model with 2 pcs batteries and 1A internal charger
	2KVA	ARPLUS-ECO2002	Tower model with 4 pcs batteries and 1A internal charger
	3KVA	ARPLUS-ECO3002	Tower model with 6 pcs batteries and 1A internal charger
	1KVA	ARPLUS-ECO1002RT	Rack model with 2 pcs batteries and 1A internal charger
	2KVA	ARPLUS-ECO2002RT	Rack model with 4 pcs batteries and 1A internal charger
	3KVA	ARPLUS-ECO3002RT	Rack model with 6 pcs batteries and 1A internal charger
External Battery Module	24V-27AH	ECO-EBC1002	Tower 24V EBC with 6pcs 9AH batteries
	48V-27AH	ECO-EBC2002	Tower 48V EBC with 12 pcs 9AH batteries
	72V-18AH	ECO-EBC3002	Tower 72V EBC with 12 pcs 9AH batteries
	24V-21AH	ECO-EBC1002RT	Rack 24V EBC with 6 pcs 7AH batteries
	48V-14AH	ECO-EBC2002RT	Rack 48V EBC with 8 pcs 7AH batteries
	72V-9AH	ECO-EBC3002RT	Rack 72V EBC with 6 pcs 9AH batteries

2.3 UPS Outlook

2.3.1 Rear View

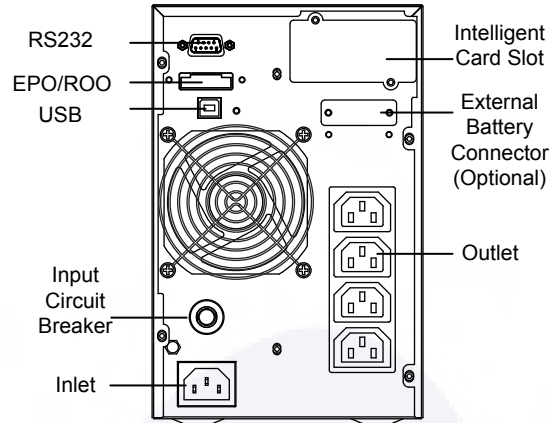

ARPLUS-ECO1002 Rear Panel

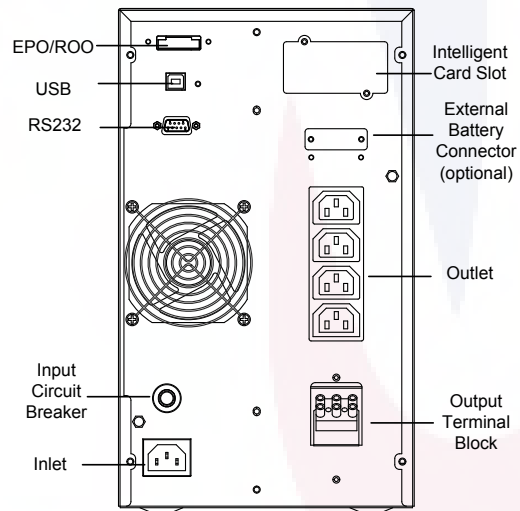

ARPLUS-ECO2002 Rear Panel

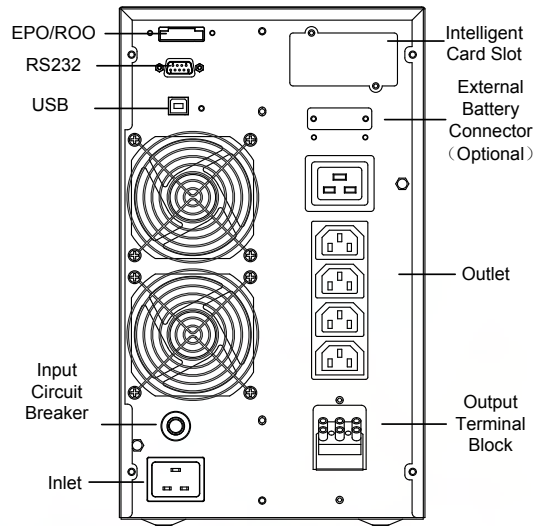

ARPLUS-ECO3002 Rear Panel

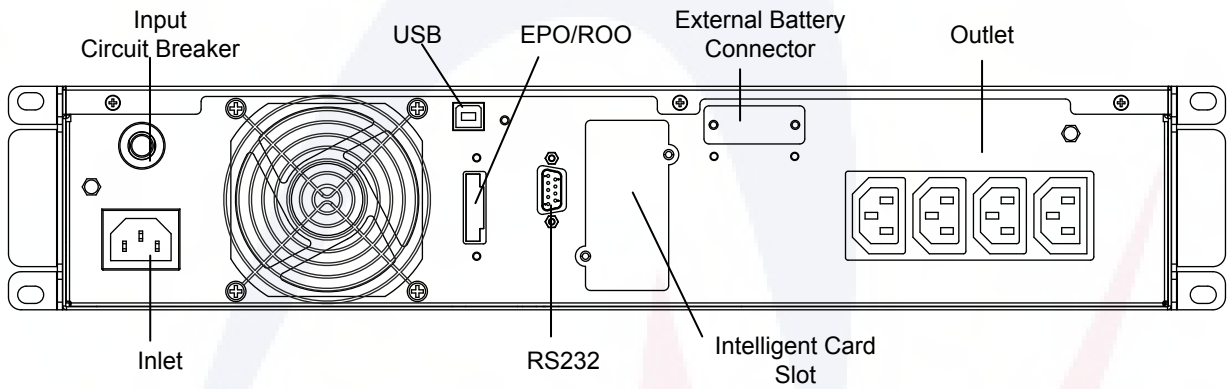

ARPLUS-ECO1002RT Rear Panel

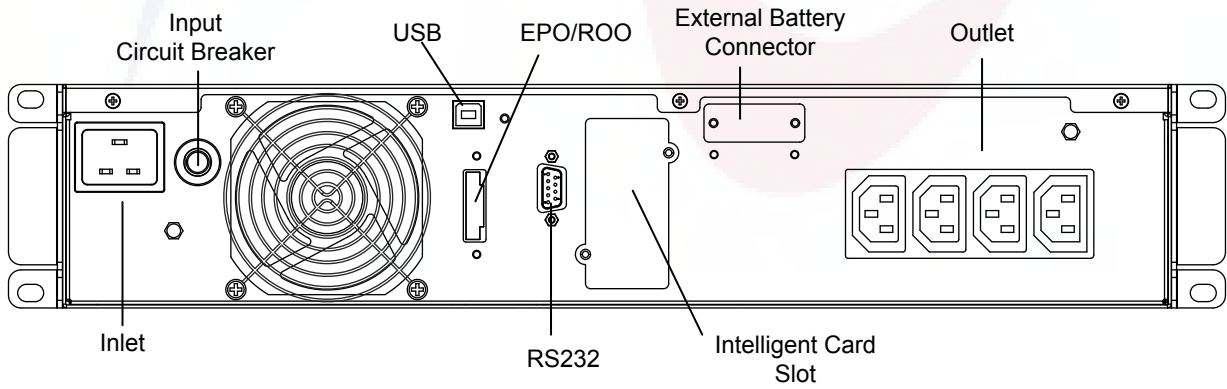

ARPLUS-ECO2002RT Rear Panel

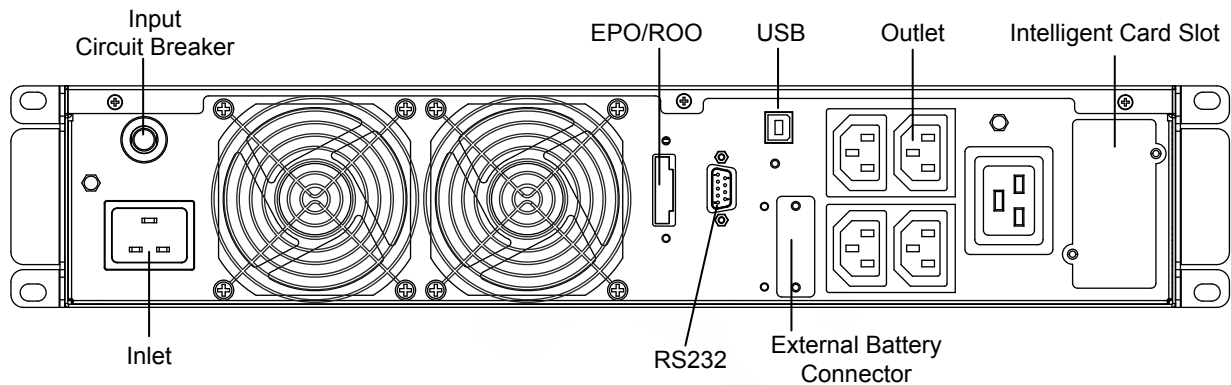

ARPLUS-ECO3002RT Rear Panel

Note:

1. The socket and terminal configuration may change for different countries or regions according to order.
2. External battery connectors available only for long backup type UPS
3. Note: It is recommended that the UPS output line is not more than 10m, the external communication line, and the machine line and the temperature detection line is not more than 3m, otherwise it may need to take installation restrictions or additional measures to suppress interference.

2.4 Internal circuit configuration

The present UPS product is a typical double conversion ONLINE UPS with internal bypass, as shown in below figure, a push-button AC circuit breaker at the front end is used for over current protection, and then an input EMI filter for filtering out noise interference. AC power pass through EMI is fed to a PFC rectifier and convert to stable high voltage DC power and supply to the DC link. At the output of the DC link, a DC/AC Inverter converts the high voltage DC power to clean and stable AC power for protecting the mission critical loading. Another branch of AC power is converted to low voltage DC power to recharge the battery. The battery powers the DC link and inverter through the DC/DC battery boosting converter in case AC mains is abnormal. During transient between AC input power and battery power, the output is sustained and smoothed by the DC link, which result in true zero interruption on AC output end. An internal automatic bypass provides a backup power supply in case overload or other unexpected abnormal situation occurs to the UPS.

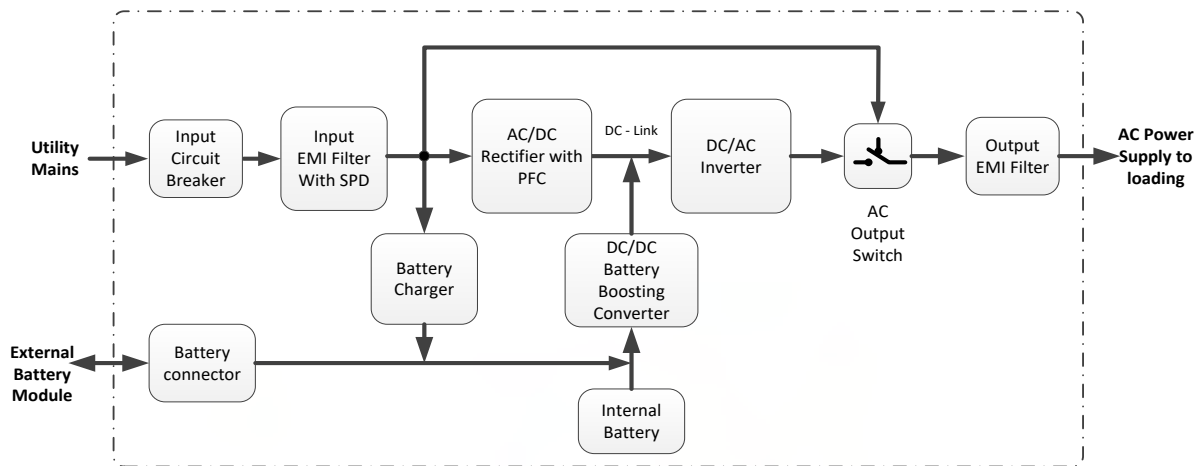

Internal circuit configuration of present UPS product

Inside the UPS, input Neutral is not bonded with PE, and grounding subject to input power distributing system, the product compatible with TN, IT, TT power distributing system, with Line, Neutral and PE or L1, L2, PE of 208/220/230/240V 50/60Hz nominal voltage.

The AC or battery power are connected to the UPS via the dedicated port, correct wiring is essential for the UPS function normally, detailed information about wiring can be found in later sections.

Chapter 3 Installation

3.1 Product inspection

- Unpacking the cabinet, Open the outer carton and remove the accessories Packed in the cabinet
- Carefully lift the cabinet out of the outer carton. Note the UPS mode with internal battery is heavy, two person or proper tools should be used to take the equipment out
- Inspection equipment
Check the product appearance, display, terminal block, socket, connector, NO contamination, and deformation should be found

Checking accessories according to below of shipping list.

Please contact the distributor if damages or lack of accessories are found.

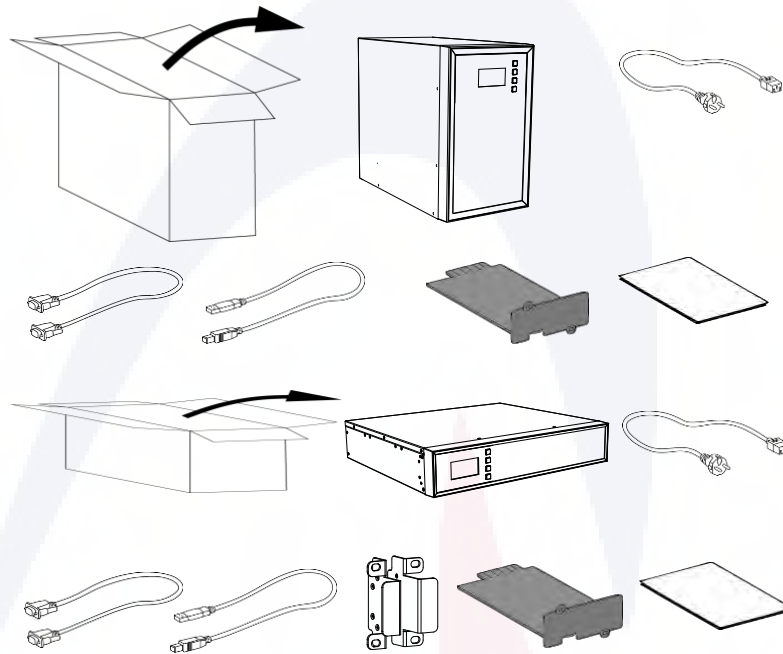

UPS accessories of shipping list:

Accessory	Quantity	Unit
User manual	1	PCS
Input Power Cord	1	PCS
RS232 Cable(optional)	1	PCS
USB Cable(optional)	1	PCS
Communication card (optional)	1	PCS
Rack ears(Only for Rack Type)	2	PCS

3.2 Installation

Because of heavy weight, a steady space needed to install the UPS. Cool, good ventilation,

less humidity and dust are required for safe and reliable operation of the UPS.

Always keep 200 mm of free space behind the UPS rear panel.

Check that the indications on the name plate located on the top cover of the UPS meets to the AC-power source and the true electrical consumption of the total load

3.3 Wiring

NOTE:

Do not apply power to the UPS until installation is totally completed.

Do not make unauthorized changes to the UPS; otherwise, damage may occur to your equipment and void your warranty.

3.3.1 Input Wiring

ARPLUS-ECO 1, 2, 3 kVA (208V/220V/230V/240V) comes with input cable with plug. Plug the input cable to appropriate mains supply socket.

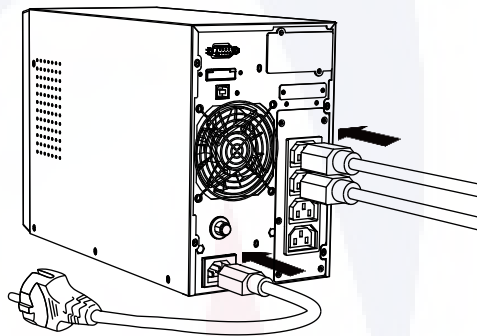

Installation of product with Power cord with plug end

Note the voltage and current rating of the product. Refer to below table for input wiring

Model	Nominal Input Voltage	Rated Input Current	Input Cable AWG/Cross-section Area	Terminal Block Tightening Torque
1K	208/220/230/ 240Vac	5.6/5.5/5.2/5.1A	Standard cable with plug	NA
2K		10/10/10/9.8A		
3K		16/16/15.5/14.4A		

Even internal over current protection breaker is embedded in the product, external switchable circuit breaker should be installed at upstream of the UPS product for safe installation and maintenance of product.

3.3.2 Output Wiring

Outlet and terminal block are available for output connection from UPS , with refer to figure in section 2.3.1: Please find rated output capacity of product , avoid overload and used wire with sufficient current rating, with refer to below table .

Model	Rating Capacity	Nominal Output Voltage	Rated output Current	Quantity of output socket	Output terminal block & wiring cable	Terminal Block Tightening Torque
1K	1kVA	208/220 /230/240Vac	4.3/4.5/4.3/4.2A	4 x IEC-C13	NA	NA
2K	2kVA		8.6/9.1/8.7/8.3A	4 x IEC-C13	16AWG/1.0mm ²	0.5Nm (4.4 Lb In)
3K	3kVA		13/13.6/13A/12.5 A	4 x IEC-C13 +1 x IEC-C20	14AWG/1.5mm ²	

Procedure for output wiring:

1. Plug the AC input cord of the equipment needs UPS protection to the Outlet of the UPS.
2. To connect more equipment than available Outlet number, please use extension cord, connect to the Outlet or output terminal block, mind the total consumption current must not exceed rated current capacity of the product.
3. The output terminal is protected by a cover, uncover the terminal, use appropriate connecting terminal , prepare well the wire.
4. Fix the prepared wired to the terminal block, find the silkscreen marking for polarity of the wiring.

3.3.3 External Battery Module

Connection of external battery is **ABSOLUTELY CRITICAL**. Any mistake may result in serious injure of electric shock or fire, damage of product below steps must be strictly followed:

Nominal Battery voltage

Model	Nominal Battery Voltage	Rated Battery Current	Recommended Wiring cable for non-standard EBC
1K	24V	45A	>10AWG/6mm ²
2K	48V	45A	>10AWG/6mm ²
3K	72V	45A	>10AWG/6mm ²

- The external battery bank must be in accordance with UPS rated battery voltage, find UPS rated battery voltage in model plant on the rear panel of the product
- Standard external battery module has an extending port, which is used to extend external battery capacity, just plug battery cable to the extending port of adjacent model and battery cable of the last module connect to the UPS battery connector on the rear panel of the UPS,

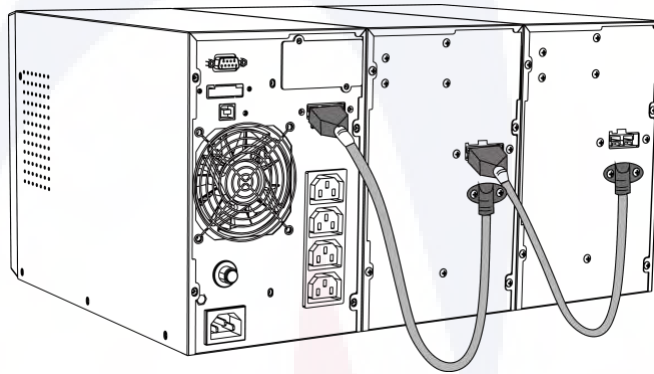

- For non-standards battery module, the external battery bank must have a cut-off device, like circuit breaker or switch with fuses.
- **TURN OFF** the cut-off device, make sure no harmful voltage can be touched on the connector.
- Use only battery bank of correct voltage, check the product rating label for correct information.
- Choose Wire with sufficient current rated, prepared well the terminal
- **CHECK THE POLARITY** of battery bank, fix wires of correct polarity to the battery bank with proper color and clear label for distinguish the polarity.
- Securely Plug / Fix the other end of the cable to UPS
- Check the polarity of the wiring and fastness of the connection
- Powered the UPS by turning on the cutoff device
- This UPS may work with a maximum of 4 extension battery cabinets.

3.3.4 Communication Cable

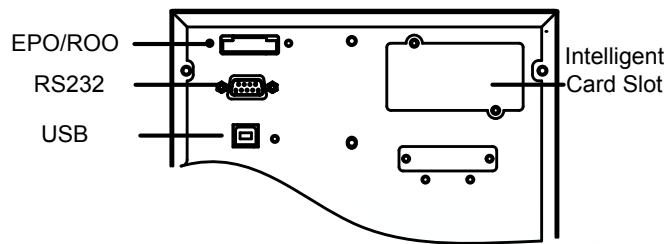

RS232: Connect UPS computer Interface (RS232) and monitor equipment through communication cable.

Intelligent Card Slot is used to install NMC (Network Management Card), AS400 Card , CMC(Centralized Monitoring Card), to implement Network Monitoring, RS485 based ModBUS protocol monitoring.

The USB port is a serial port emulator will allow you to create virtual RS232 ports linked via a USB Port, the UPS could be manage through the same management software, while does not support HID USB Power part operating mode.

The Product also provide optional Modbus Port, Relay Dry contact card, refer to optional port user manual for application.

3.3.5 Software

Free Software Download – WinPower

WinPower is brand new UPS monitoring software, which provides user-friendly interface to monitor and control your UPS. This unique software provides safely auto shutdown for multi-computer systems while power failure. With this software, users can monitor and control any UPS on the same LAN no matter how far from the UPS.

Installation procedure:

Visit website for downloading the management software: <http://www.ups-software-download.com>

Choose the operation system you need and follow the instruction described on the website to download the software

When downloading all required files from the internet, enter the serial No: 511C1-01220-0100-

478DF2A to install the software.

When your computer restarts, the WinPower software will appear as a green plug icon located in the system tray, near the clock

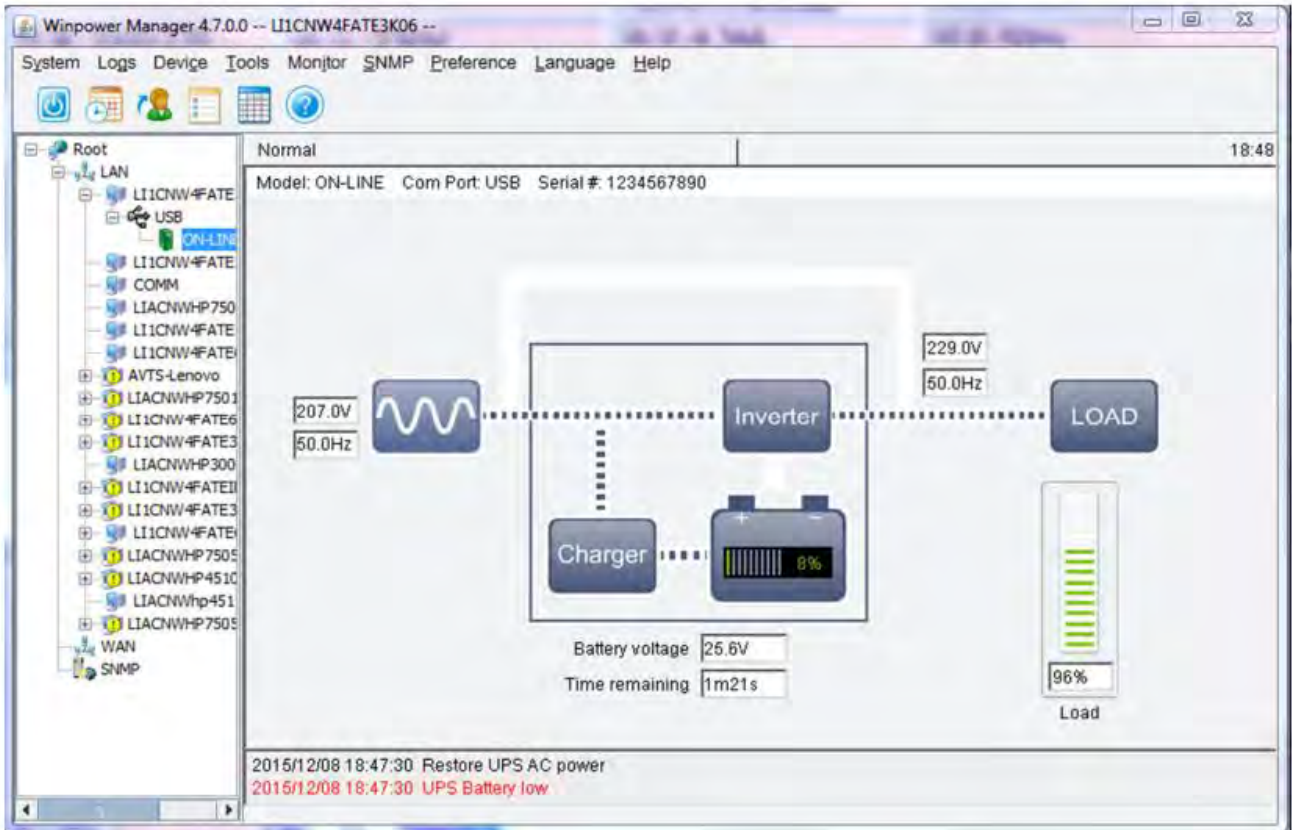

Chapter 4 Panel & Operation Guide

4.1 Display panel

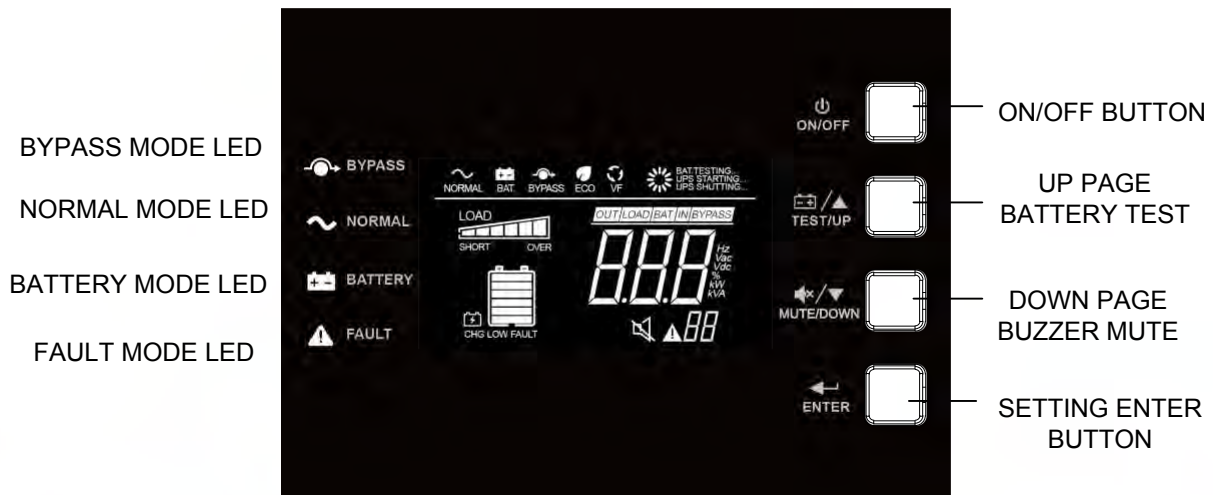

LCD Display Panel

4.1.1 ON/OFF Button

ON/OFF Button is used to turn on/off the UPS

4.1.2 Setting Enter button

Enter button is used to enter setting mode and confirm change of the setting

4.1.3 Up Page/ Battery Self-test Button



The Up-page Button is used to switch the display the LCD display information, and activate the battery self-test function

4.1.4 Down Page/Buzzer Muting function

The Down Page Button can also use to switch the display the LCD display information, and muted/recover the buzzer alarm function

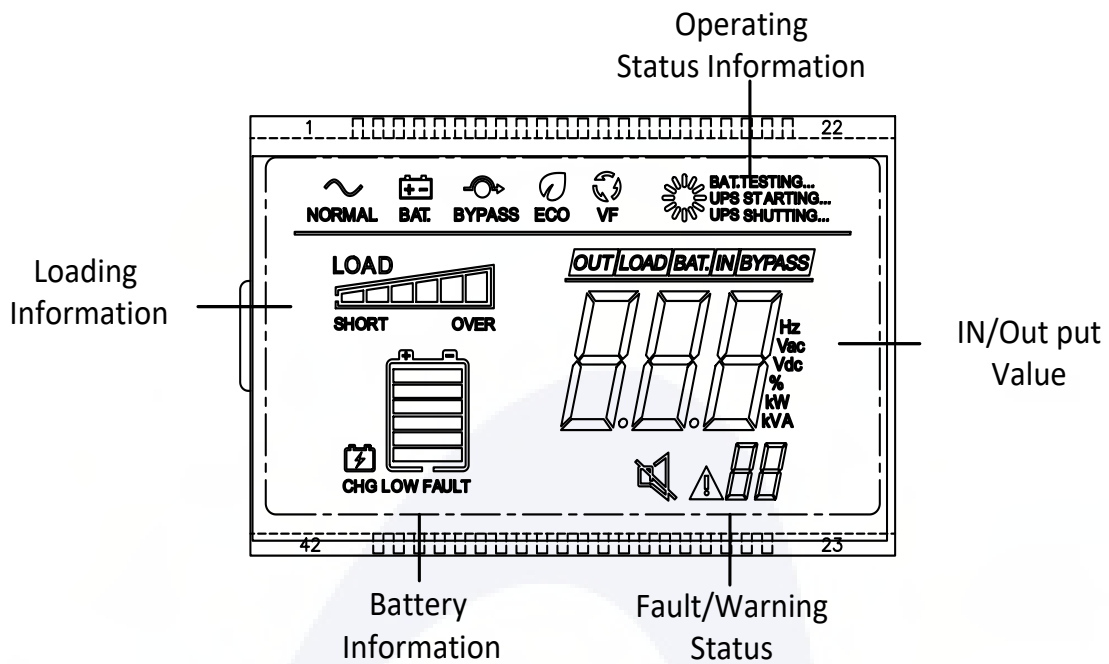
4.1.5 LCD Display

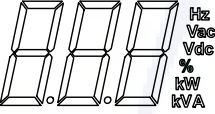

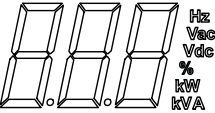
icon	Function description
Input Source Information	
	Indicates the AC input.
	Indicate input voltage, input frequency, battery voltage.
AC Output Information	
	Indicates the AC Output.
	Indicate output voltage, frequency, loading percent.
Fault Information	

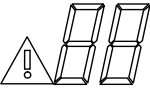
	<p>Indicates the warning or fault Status occurs to the UPS. Warning: flashing with warning code at output digit. Fault: lighting with fault code at output digit.</p>
---	---

Battery Information

	<p>Indicates battery level by 0-20%, 21-40%, 41-55% ,56-70%, 71-85% and 86-100% in battery mode .</p> <p>LOW: Indicates low voltage of the battery.</p> <p>FAULT: Indicates that the UPS is faulty.</p>
---	---





Battery Charge Information





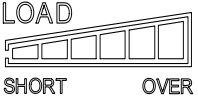





	<p>Indicates charging status in line mode.</p>
---	--

Silent mode

	<p>Indicates that the UPS has been enabled in silent mode</p>
---	---

Load Information

<p>OVER LOAD</p>	<p>Indicates overload.</p>	
	<p>Indicates the load level by 0-15%, 16-30%, 31-45%, 46-60%, 61-80% and 81-100%.</p> <p>SHORT: Indicates with a small load. OVER: Indicates overload.</p>	
	<p>0-15%</p>	<p>16-30%</p>
		
	<p>31-45%</p>	<p>46-60%</p>
		
	<p>61-80%</p>	<p>81-100%</p>

		
Mode Operation Information		
 NORMAL	Online mode	
 BAT.	On battery mode, AC Mains is abnormal, Battery supply inverter output	
 ECO	On ECO mode	
 BYPASS	On bypass Mode, the load is not protected by the UPS	
 VF	On CVCF (constant voltage, constant frequency) Mode	
 BAT.TESTING...	Battery Testing Ongoing	
 UPS STARTING...	UPS is turning On	
 UPS SHUTTING...	UPS is turning Off	

4.1.6 Parameter Setting

On bypass/standby mode, long press the Enter Key for 2 seconds, the UPS Enter Parameter Setting mode, and the LCD display as follow

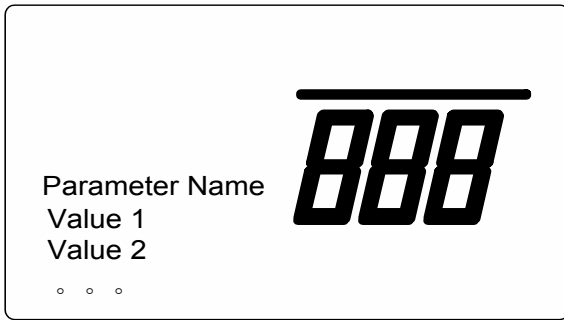

Parameter name indicate the parameter item to set .

The value is the target setting value





Use “Upward” or “Downward” to choose the item to set and setting value

The Parameter is saved only when the UPS is completely shut down under battery mode. Means that battery need to well connected to complete parameter setting, after finish parameter setting, cut off mains input and wait about 1min until the UPS automatically shut down and save the change to the memory. New Parameter value will take effect in next turn-on.

● 01: Output Voltage



Display	Value
	<p>Parameter Item: Output Voltage</p> <p>208: means output voltage will be 208Vac 220: means output voltage will be 220Vac 230: means output voltage will be 230Vac 240: means output voltage will be 240Vac</p>
	<p>Use “UP Page” or “Down Page” Button to find desired voltage value , then Use “ENTER” button to activate the value, once the value is active, there is “Vac” icon shown behind the value</p>
	<p>Example:</p>

- 02: Output frequency



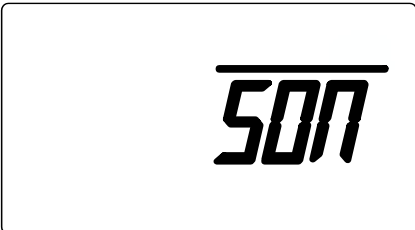



Display	Value
	<p>Parameter Item: Output frequency</p> <p>000: auto adaptive, the UPS will automatically detect the mains frequency to determined it output frequency when it wake up by mains power on</p> <p>050: Fixed 50Hz rated frequency</p> <p>060: Fixed 60Hz rated frequency</p>
	<p>Use “UP Page” or “Down Page” Button to find desired voltage value , then Use “ENTER” button to activate the value, once the value is active, there is “Hz” icon shown behind the value</p>
	<p>Example:</p>
	

- 03: Auto turn on upon mains power on

Display	Value
	<p>Auto turn ON Function setting</p> <p>ON: Enable auto turn on function, when the UPS wake by AC mains apply , the UPS will automatically turn on and run in line mode</p> <p>OFF: Disable auto turn on function, the UPS will stay on standby mode /bypass mode until manual turn on operation</p> <p>Use “UP Page” or “Down Page” Button to find desired voltage value , then Use “ENTER” button to activate the value, once the value is active, there is “OUT” icon shown above the value</p>

	Example:
	







● 04: EPO Setting

Display	Value
	Emergency Power OFF (EPO) switch response setting
	001: Enable EPO
	000: Disable EPO
	0n1: EPO activated for EPO switch open
	0n0: EPO activated for EPO switch close
	<p>Use “UP Page” or “Down Page” Button to find desired voltage value , then Use “ENTER” button to activate the value, once the value is active, there is “OUT” icon shown above the value</p>
	Example:
	





--	--





● 05: ROO Setting

Display	Value
	<p>Remote On OFF (ROO) switch response setting</p> <p>001: Enable ROO 000: Disable ROO 0n1: ROO activated (Turn on UPS) for ROO switch open 0n0: ROO activated (Turn on UPS) for ROO switch close</p>
	<p>Use “UP Page” or “Down Page” Button to find desired voltage value , then Use “ENTER” button to activate the value, once the value is active, there is “OUT” icon shown above the value</p>
	<p>Example:</p>
	
	

● **06: Bypass Setting**

Display	Value
  	<p>Entity Bypass setting, this item it to set bypass output when UPS is not on inverter output mode(line mode / battery mode), if the setting is disable bypass output is turn OFF when UPS is not on inverter output mode(line mode / battery mode) , on the contrary, if the setting is enable , the bypass output is turn ON when UPS is not on inverter output mode(line mode / battery mode) if only mains input is normal, please note the UPS should be turn on if the load need to be protected by the UPS when this setting is enable.</p> <p>ON: Enable bypass mode OFF: Disable bypass mode</p> <p>Use “UP Page” or “Down Page” Button to find desired voltage value , then Use “ENTER” button to activate the value, once the value is active, there is “OUT” icon shown above the value</p> <p>Example:</p> 

● **07: ECO MODE**

Display	Value
 	<p>Economic (ECO) Mode Enable /Disable setting</p> <p>ON: Enable Economy (ECO) mode OFF: Disable Economy (ECO) mode</p> <p>Use “UP Page” or “Down Page” Button to find desired voltage value, then Use “ENTER” button to activate the value, once the value is active, there is “OUT” icon shown above the value</p> <p>Example:</p>

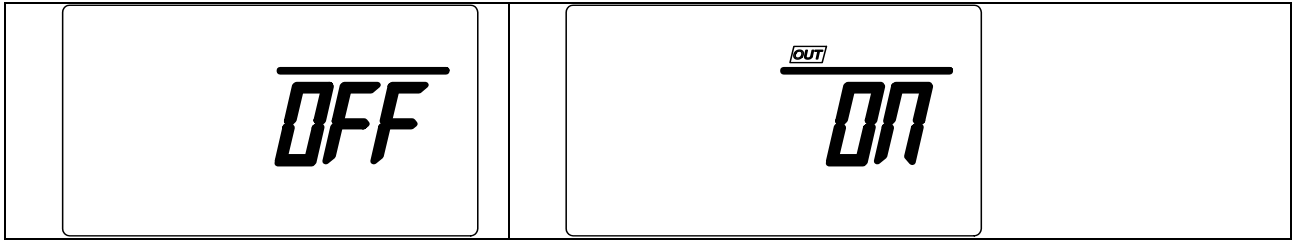

4.2 UPS Working Mode

4.2.1 Normal mode

Turn on the UPS, if the mains supply is normal, UPS will work in Normal mode (Line mode) and converse and filter the mains input for clean and stable AC output. The indicators display will show the operating mode.

If loading level is over 100% rated capacity, the buzzer beeps to remind you overloaded that you must reduce unnecessary load until the UPS loading level is less than 100%.

If the battery indicator blinks cyclically, it shows the UPS disconnect from battery or the battery condition is abnormal. Please check the battery connection and battery condition for prevent UPS output unexpected interruption upon mains supply power losses.

4.2.2 Battery mode

When mains utility power is abnormal condition, such as blackout or fluctuation in voltage, frequency as well as waveform, UPS will automatically switch to run in battery mode, in which the battery work as energy source, and maintain the stable AC power supply at the output side of the UPS product.

In the Battery mode, UPS will beep once every 4s. the user can mute the buzzer beep by the down page(mute) button.

If the battery capacity is very low, the UPS will beep once every 1S. It is alarm to take off the load as soon as possible.

Backup function can be tested through battery self-test via Up Page (battery test) button

4.2.3 Bypass mode

The ups work on bypass mode when the UPS start up or abnormal situation occurs to the converters and

cannot work properly. The mains power is fed to the load through the bypass circuit in such mode without protection. Please note that when UPS running in bypass mode, UPS has no backup function either, because load power is supplied by the utility power directly.

4.3 Operation

4.3.1 Turn on UPS

Turning on with utility power

Connect the mains input to the UPS, press and hold the ON/OFF button for more than 3 seconds until the buzzer beeps. the UPS begins to conduct self-test, seconds later, utility power icon and the Inverter icon shown, and the UPS begins to output supply and operate under the Normal mode. If the utility power is abnormal, the UPS will work under the Battery mode.

Turning on without utility power

With no mains input to feed the UPS, press, and hold the ON/OFF for than 3 seconds, the UPS response with a buzzer beep. In the turn on process, the UPS has the same operation as if it is connected to utility power that the utility power icon will not show, instead the battery icon shown.

4.3.2 Turn off UPS

The operation of powering down contains: Power down under Normal mode and Battery mode

Turn off UPS under the Normal mode

Press and hold the ON/OFF button for more than 3 second to turn off UPS. If bypass mode is enabled, the bypass indicator will be turned on to indicate that UPS is working in bypass mode. To cut off the output of the UPS, simply cut off the utility power. Finally, not any display is shown on the front panel and no output is available from the UPS outlets.

Turn off UPS under the Battery mode

Press and hold the “ON/OFF” for 3 second to turn off the UPS. The UPS cut off UPS output supply, and the UPS totally turn off after approximately 1 minute.

4.3.3 Enter Setting Mode

When UPS Work on Bypass or Standby Mode, Press the Setting Enter Button for 5 seconds, the UPS enter setting mode, accept setting of output voltage, frequency, battery number, bypass enable/disable, ECO mode enable /disable ,EPO function ON/OFF.

Use Up page and down Page to change the setting and short press the setting for confirm the change

After setting, turn off the mains power supply, wait the UPS turn off under battery mode until display if total off , turn on the UPS again to activate the setting change.

4.3.4 Battery Self-test

In Normal mode, press the Up Page Button for more than 4 seconds until the buzzer beeps. he UPS switch to battery test mode, to check the status of the battery, the UPS exit the battery test mode if the battery abnormal and present alarm with the battery icon flashing. If test mode ends up with normal, the UPS switch to normal mode automatically

4.3.5 Buzzer Mute

When UPS is on battery or bypass mode, UPS will warn with warning tone (Battery mode four seconds one tone: Bypass mode two minutes. You can disable or enable the buzzer tone manually.

In the battery and bypass mode, push Down Page button for about 4 seconds until you here a buzzer beep. the buzzer alarm can be muted. Press the button for 4seconds again to recover the buzzer alarm function.

The Buzzer Muting is valid only in battery mode, and invalid for any other UPS alarm.

Chapter 5 Maintenance

5.1 Routine Maintain

To make sure UPS work normal, appropriate maintenance should be schedule periodically, below items should be checked.

Check UPS running status.

If the utility power is normal, UPS should work in line mode or in battery mode. And there is no warning or fault indication.

Check UPS running mode switch.

Cut off the line input to simulate the utility power interrupt, UPS should transfer to battery mode, and connect the line input, UPS return to line mode again.

Check UPS panel.

Check UPS panel display if it is consistent with UPS running mode.

5.2 Battery Maintain

Typical life span of a lead acid battery is 300 cycle or 2~3years in an environment of 15-25°C ambient temperature.

Battery is a very important part in the UPS system. The life of battery affected by the environment temperature and cycling use times, high temperature and deep discharge will decrease the battery life.

Battery test can find out battery most problem in battery, for external battery bank, voltage of each battery unit can be an indicator for the battery health status, under not charged condition, battery voltage of in bad unit condition will drop quickly or significantly stray from that of the rest unit in the same battery bank . Professional battery check is to test battery with battery diagnostic instrument, in which battery impedance is measure,

If UPS is not used, it is suggested to charge the battery once every 6 months.

Normally, the battery should be discharged once every 4 to 6 months.

The battery replacement should be done by qualified technician , please get the advice from local distributor

Chapter 6 Trouble shooting

When any trouble with UPS, please check the problem refer to the table below first. If the problem cannot be solved, please contact local supplier.

6.1 LCD Warning and Fault Code

Fault code	Description	Possible cause and solution
01	UPS start up not success	Battery Low
		UPS Internal failure, Contact distributor for service
02	Internal DC BUS over-voltage protection	Half-wave rectifier load(hair dryer , half-wave solenoid valve , energy re-generated type load (motor, huge transformer, capacitor with residue charge, remove this kind of load and turn on the UPS again.
		Over mains voltage, turn on the UPS again.
		UPS Internal failure, Contact distributor for service
03	Internal DC BUS under-voltage protection	Battery Low or overload
		UPS Internal failure, Contact distributor for service
10	UPS Output Short-Circuit	Remove short-circuit equipment from UPS
22	UPS Overload	Reduce loading capacity below UPS rating
23	UPS Over Temperature	Make sure UPS should work in ambient of -10-45°C, if the ambient temperature can't meet this spec. Try reducing loading
		Check ventilation inlet of the UPS ON from panel and outlet on the rear panel is not blocked
		UPS Internal failure, Contact distributor for service
29	UPS Input rectifier protection	Low input voltage and overload
		UPS Internal failure, Contact distributor for service
57	Battery UN-connected	Check battery input wiring and battery cutoff device such as circuit breaker etc.
59	Charger Fail	UPS Internal failure, Contact distributor for service
60	EPO activated	Reset the External EPO switch, if no EPO switch install, turn off EPO function via the operating panel
Battery Icon Flashing		Battery not connected or battery low
		Charger failure, Contact distributor for service
UPS not working normal line mode , With normal mains input		Make sure Input circuit breaker is ON
		Turn on the UPS via ON/OFF button
Backup time is not as long as expected		Battery low, recharge the battery long enough time
		Overload, reduce the loading
		Battery aged, Contact distributor for service
UPS do not turn ON after pressing ON/OFF button		Press the ON/OFF button long enough time, 3seconds , and hear a buzzer beep for acknowledging the correct TURN ON operation
		Battery low or not connected
		UPS Internal failure, Contact distributor for service

Chapter 7 Specification

7.1 Single phase input Tower model Specification

Model item		ECO1002	ECO2002	ECO3002
Nominal power ^①		1000VA/900W	2000VA/1800W	3000VA/2700W
AC Input	Input system	Single phase (L/N+PE)		
	Nominal voltage	HV: 208/220/230/240Vac		
	Frequency	50/60Hz		
	Voltage range	HV: 90~275VAC±5VAC		
	Frequency range	(40~70)±0.5Hz		
	Input power factor	>0.99		
	Bypass Voltage Range	HV:187~265V/ (120~275Vac max)		
Battery Input	Nominal Voltage	24V	48V	72
	Battery Capacity & Quantity	12V x 2pcs	12V/ x 4pcs	12V/9AH x 6p
	Backup Time	Half loaded ≥12 minutes, Full loaded ≥5 minutes (standard)		
	Battery charger time	Charger to 90% battery capacity in 5 hours(standard) Dependent on the capacity of external batteries (long backup time)		
AC Output	Output wiring system	Single phase (L/N+PE)		
	Inverter Mode Output voltage	HV: 208/220/230/240Vac		
	Waveform	Sine Wave		
	Harmonic Distortion	THD<2% (linear load)		
	Output frequency	50/60±4Hz (Sync mode) 50/60Hz±1% (Fix Freq. mode)		
	Overload capability	105 ~ 125%≥ 60s, 126 ~ 150%≥30s The recover point is 70%		
	Output short circuit current	15A/60ms	30A/60ms	45A/60ms
	Transfer time	Battery <-> Line Mode :0ms		
Efficiency	Line Mode	88%	89%	90%
	Battery Mode	85%	86%	87%
Interface		RS232, USB, Intelligent Slot, EPO, ROO		
Alarm Function		AC/DC input under abnormal, overload condition and Inverter problems		
Protection Function		AC input or output above or below the range of voltage, overload, over temperature and short circuit protection		
Noise		<50dB		
IP rating		IP20		

1. Subject to safety regulation and rating of power cord/socket, output power might need derating, find detail on the product label
2. Subject to change according to order, check the product name plate for specified battery voltage information.

7.2 Mechanical

Model	W x H x L(mm)	Weight(kg)	Remark
ECO1002	144×224×349	8.9	Internal 2 pcs Battery
ECO2002	190×323×366	14.0	Internal 4 pcs Battery
ECO3002	190×323×366	21.6	Internal 6 pcs Battery
ECO1002RT	439.8x88(2U)×428	13.0	Internal 2pcs*12V/7AH Battery
ECO2002RT	439.8x88(2U)×428	18.5	Internal 4pcs*12V/7AH Battery
ECO3002RT	439.8x88(2U)×640	21.9	Internal 6pcs*12V/9AH Battery
ECO-EBC1000T24V	144x228x356	19.3	Tower Type EBC with 6pcs x 12V/7AH Battery in 24Vdc
ECO-EBC2000T48V	190x327x399	37.7	Tower Type EBC with 12pcs x 12V/7AH Battery in 48Vdc
ECO-EBC3000T72V	190x327x399	37.7	Tower Type EBC with 12pcs x 12V/9AH Battery in 72Vdc
ECO-EBC1000RT24V	439.8 x88(2U)×428	17.9	Rack Type EBC with 6pcs x 12V/7AH Battery in 24Vdc
ECO-EBC2000RT48V	439.8.x88(2U)×428	21.9	Rack Type EBC with 8pcs x 12V/7AH Battery in 48Vdc
ECO-EBC3000RT72V	439.8 x88(2U)×640	21.5	Rack Type EBC with 12pcs x 12V/9AH Battery in 72Vdc

7.3 Environmental

ITEM	Normal range
Ambient temperature	- 20°C~ +40°C
Environment humidity	0~97%, no condensing
Altitude	no derating for lower than 1000M: Over 1000m :1% derating for every 100M rise, Max. 3000M
Storage temperature	-25°C~+55°C

7.4 EMC & Safety Regulation

ITEM	Standard	Level
EMC	IEC62040-2	C2
Safety	EN IEC62040-1	/

Warranty

- Serial number of the product or sales contract is credentials to the warranty.
- In case of UPS fault, please contact local service center and dealer.

This limited warranty does not apply to conditions as follows:

- Damage or loss resulted from force majeure or external causes.
- Warranty period expired.
- The product serial number is missed or modified.
- Disassemble or modifications to the product without authorization.
- Man-made damage